

**POTENTIAL OF CELL CYCLE GENES *ARATH CYCD2* AND *MUSA
CYCD2* FOR THE IMPROVEMENT OF TRANSFORMATION AND
REGENERATION EFFICIENCY OF BANANA (CV “SUKALI
NDIIZI”)**

**SAMUKOYA CLARA
BBLT (HONS), MUK**

**A DISSERTATION SUBMITTED TO SCHOOL OF GRADUATE STUDIES IN
PARTIAL FULFILMENT OF THE REQUIREMENTS FOR THE AWARD OF
DEGREE OF MASTER OF SCIENCE IN BIOMEDICAL LABORATORY
SCIENCE AND MANAGEMENT OF MAKERERE UNIVERSITY**

MARCH, 2011

DECLARATION

I, **Samukoya Clara**, do hereby declare that the dissertation entitled “Potential of cell cycle genes *Arath cycD2* and *Musa cycD2* for the improvement of transformation and regeneration efficiency of banana (cv. “sukali ndiizi”) is original and has not been submitted to any other university/institution for any degree award.

Signature..... Date.....

This dissertation has been submitted for examination with our approval as supervisors:

Signed.....Date.....

Dr. **ANN NANTEZA**, PhD,

Department of Parasitology and Microbiology,

Faculty of Veterinary medicine,

Makerere University.

Signed.....Date.....

Ass. Professor, Dr. **GERARD MUTUMBA**, PhD,

Department of Botany,

Faculty of Science,

Makerere University.

DEDICATION

To my two dearest sons Emmanuel Kalya and Enock Krop, my husband Arem Andrew and my father Samson Samukoya, for the relentless support they gave me when I was undertaking this study.

ACKNOWLEDGEMENTS

My sincere gratitude is expressed to all those who gave me the support to successfully complete this work. Firstly, this work was made possible by the financial support of BecA Net through the National Banana Research Program of the National Agricultural Research Organization, Kawanda to which I am very grateful. Secondly, Special thanks go to Professor Wilberforce Tushemereirwe, the Head of the National Banana Research Programme, for permission granted to me to use the program's time and facilities for my studies. Dr. Ann Nanteza and Associate Professor, Dr. Gerard Mutumba deserve special thanks for their unconditional advice, guidance and all the supervision of the practical work and preparation of this report. My appreciation goes to Mr. Talengera David who was directly involved in this study not only in generation of the idea about this topic but also in all the technical aspects as well as guidance in developing and perfecting the research. I also thank Dr. Geoffrey Arinaitwe, and Dr. Charles Changa, for their guidance they readily gave whenever approached. Many thanks go to Ms Margret Atim who not only analyzed my data but encouraged me to do it myself by unconditionally teaching me. I am as well very much indebted to the staff of the National Biotechnology Center, Kawanda, in particular Ms Amumpaire Doreen, Mr. Bwengye Grace, Ms Betty Magambo, Ms Lamwaka Pamela, Mr. Abu Muwonge, Mr. Moses Tindamanyire, Mr Basheija Henry, Alice Bukenya, Mr. Allan Male, Ms Rebecca Nakaccwa for their technical support during my research. I can never forget to appreciate the contribution of my house girl, Sharon, who stably stayed with and nursed my children well during the time when I was undertaking this study.

Above all, I am very grateful to my husband Arem Andrew and my two dearest sons Emmanuel Kalya and Enock Krop who not only allowed me to use their golden time for my studies but also encouraged me at all times and were patient enough to see me through.

Last but not least, I thank the almighty God for good health and wisdom to successfully sail me through. To Him is the glory.

TABLE OF CONTENTS

DECLARATION	II
DEDICATION	III
ACKNOWLEDGEMENTS	IV
LIST OF FIGURES	IX
LIST OF TABLES	XI
LIST OF ABBREVIATIONS USED	XII
ABSTRACT	XIV
CHAPTER ONE: INTRODUCTION	1
1.1 Background	1
1.2 Statement of the problem	3
1.3 Justification of the study	4
1.4 General objective	5
1.5 Specific objectives	5
1.6 Hypotheses	6
CHAPTER TWO: LITERATURE REVIEW	7
2.1 Banana germplasm improvement	7
2.1.1 Genetic transformation and regeneration of bananas	8
2.1.2 <i>Agrobacterium</i> mediated transformation	10

2.1.3	Factors influencing <i>Agrobacterium</i> mediated transformation	11
2.2	Cell cycle regulation and cell division.....	12
2.3	The effect of <i>CycD</i> genes and G1-S transition on regeneration of plants	14
CHAPTER THREE: MATERIALS AND METHODS		17
3.1	Experimental site	17
3.2	Vectors and bacteria manipulations	17
3.2.1	Cloning of <i>Arath CycD2</i> and <i>Musa CycD2</i> gene constructs.....	17
3.2.2	Preparation of competent bacterial cells and plasmid purification	20
3.2.3	Transformation of competent <i>E.coli</i> cells and Plasmid purification.....	21
3.2.5	Transformation of competent <i>Agrobacterium</i> cells	22
3.3	Transformation of “Sukali ndiizi” cells	22
3.4	Selection and regeneration of “Sukali ndiizi” transgenic plants.....	23
3.6	Molecular characterization of “Sukali ndiizi” transformants	24
3.6.1	DNA isolation from “Sukali ndiizi” plants	24
3.6.2	PCR analysis of “Sukali ndiizi” regenerants	25
CHAPTER FOUR: RESULTS		28
4.1	Cloning of <i>Arath CycD2</i> and <i>Musa CycD2</i> genes	28
4.2.	Transformation and regeneration of “Sukali ndiizi” embryogenic cells with <i>Arath CycD2</i> and <i>MusaCycD2</i>	29
4.2.1	Histochemical GUS assay of transient <i>CycD</i> -GUS gene transformed banana cells.....	29
4.2.2	Selection and regeneration of “Sukali ndiizi” transformants.....	31
4.3	Characterisation of “Sukali ndiizi” transgenic lines	35
4.3.1	Histochemical GUS assay of transformed lines.....	35

4.3.2	DNA extraction from “Sukali ndiizi” plants.....	36
4.3.3.	PCR analysis of “Sukali ndiizi” regenerants	36
CHAPTER FIVE: DISCUSSION.....		38
CHAPTER SIX: CONCLUSIONS AND RECOMMENDATIONS		44
6.1	CONCLUSIONS.....	44
6.2	RECOMMENDATIONS.....	45
REFERENCES		46
APPENDICES		544
Appendix 1. GUS staining solution (final concentrations):.....		544
Appendix 2. DNA Extraction Buffer (Final concentrations):.....		54
Appendix 3. TE Buffer:		555
Appendix 4. TAE electrophoresis buffer (50x stock).....		555

LIST OF FIGURES

Figure 2.1 Diagrammatic presentations of different methods of plant breeding.....	8
Figure 2.2 Schematic presentation of <i>Agrobacterium</i> mediated transformation.....	11
Figure 2.3 Phases of the cell cycle	1313
Figure 3.1 Schematic diagram of the construction of expression vector, pC1305.1 containing <i>Musa CycD2</i> or <i>Arath CycD2</i> and Gus genes, used in the study to express the genes in <i>E.Coli</i> and <i>Agrobacterium Tumefaciens</i> accordingly.....	18
Figure 3.2 Vector map for gene construct with <i>Musa CycD</i> or <i>Arath CycD2</i> and GUS genes fused together.....	19
Figure 4.1 Gel electrophoresis of PCR and restricted plasmid DNA on a 1% agarose gels.....	28
Figure 4.2 Histochemical assay for transient expression of gus gene in Sukali ndiizi ECS transformed with different <i>CycD</i> –gus gene after overnight incubation at 37°C	30
Figure 4.3 Three months cultures on selective M3 medium with black dying cells and persisting white cells resistant to hygromycin.....	32
Figure 4.4 Surviving embryos, four months after transformation developing on selective RDI medium.....	32
Figure 4.5 Shoots germinating from selective M4 medium.....	33

Figure 4.6 One month old germinated shoots growing on non-selective proliferation medium in the presence of light.....33

Figure 4.7 Histochemical GUS assay of pieces of root (A) corm (B) and leaf (C) of “Sukali ndiizi”35

Figure 4.8 Agarose gel for DNA quality and quantity determination.....36

Figure 4.9 Agarose gel for analysis of representative transgenic plants from ‘Sukali ndiizi’ containing *CycD2* together with *hptII* genes by PCR.....37

LIST OF TABLES

Table 3.1 Primers used, their sequences, annealing temperature and expected band sizes.....	26
Table 4.1 Enhanced transformation in “Sukali ndiizi” using <i>CyclinD2</i> genes	34

LIST OF ABBREVIATIONS USED

ANOVA	Analysis of variance
BSA	Bovine serum albumin
CaMV	Cauliflower mosaic virus
Cdk	Cyclin-dependent kinase
CKI	Cyclin-dependent kinase inhibitors
<i>CycD</i>	<i>Cyclin D</i> gene
DNA	Deoxyribonucleic acid
E2F-	E2 factor, cellular factor required for E2 viral promoter activation
EAHB	East African Highland Bananas
ECS	Embryogenic Cell Suspension
EDTA	Ethylene di-amine tetra acetic acid
FAO	Food and Agriculture Organization
G1 phase	Gap 1 phase of the cell cycle
G2 phase	Gap 2 phase of the cell cycle
LB	Luria Bertani
M phase	Mitosis phase of the cell cycle
mg/l	Miligrammes per litre
mM	Millimolar
NARO	National Agriculture Research Organization
PCR	Polymerase Chain Reaction
Rb	Retinoblastoma
rpm	Revolutions per minute

S phase	Synthesis phase of the cell cycle
PCV	Packed cell volume
<i>Taq</i>	<i>Thermus aquaticus</i> bacterium
T-DNA	Transferred DNA
TE	Tris-EDTA buffer
TAE	Tris Acetic acid – EDTA buffer
YM	Yeast mannitol

ABSTRACT

Available techniques for the genetic transformation with important genes could overcome some of the agronomic and environmental problems limiting conventional breeding of bananas. Although it is possible to transform bananas, broad application of the technology is limited because of the low overall efficiency and lack of reliability of the technique. This research reports on the potential of *CycD2* genes to improve transformation and regeneration efficiency of banana (cv. "Sukali ndiizi"). Two genes *Arath CycD2* and *Musa CycD2* were evaluated for the cell cycle modification of the embryogenic cell suspension that is conventionally used in banana genetic engineering at the National Biotechnology Centre, Kawanda. The *UidA* (GUS) gene was used as reporter to establish transient transformation efficiency. The GUS reporter gene, which was used for quantification of transformants was therefore, fused with each of the *CycD2* genes in the binary vector, pC1305.1. The Cauliflower mosaic virus 35S promoter was used to drive both *CycD2* and the *GUS* reporter genes. Results indicated that cell cycle genes could significantly increase the competence of banana cells for uptake and integration of foreign genes. The Gus assay analyses of transformed cells showed a success rate of 80% to 90% for all the constructs including the control transformed with the empty vector without *CycD2* gene. To assess whether the *CycD2* genes could improve the regeneration efficiency of "Sukali ndiizi", the transformed cells were cultured on selection media and the hygromycin resistant colonies developed into shoots. The gus assay of the regenerants showed that the genes were expressed in different parts of the plants (roots, corm and leaves). The PCR analysis of DNA from these shoots indicated that *Musa CycD2* and *Arath CycD2* genes significantly improve the

regeneration of transgenic “Sukali ndiizi” cells. The regeneration efficiency of the embryogenic colonies of *CycD2* genes (47%-62%) was much higher than that of the control without *CycD2* (18%). The results show that “Sukali ndiizi” cells are highly competent and transformable by *Agrobacterium* mediated transformation system and *CycD2* genes have the potential to significantly improve regeneration efficiency of “Sukali ndiizi” cells”. This study contributes to the current information about improvement of transformation and regeneration efficiency of bananas and highlights the potential of *CycD2* genes in the improvement of regeneration of transgenic plants.

CHAPTER ONE: INTRODUCTION

1.1 Background

Bananas and plantains (Clones of genus *Musa*, family *Musaceae*) are among the oldest crop plants and are of great importance in the world due to their commercial and nutritional value. The FAO, in 1999, estimated that the annual world production of Bananas is 86 million tons. In Uganda banana is one of the most important staple crops, contributing about 30% of the total food consumption and 14% total crop value (Kalyebara *et al.*, 2005). About 24% of the agricultural households are engaged in banana production due to its many other attributes like carbohydrate staple, a source of animal feeds, production of alcoholic beverage, construction materials (thatch and binding ropes) and handicrafts (mats, baskets, hand bags, necklaces and decorations). The crop also provides soil surface cover, reduces soil erosion on steep slopes and a principal source of mulch for maintaining and improving soil fertility (Karugaba and Kimaru, 1999).

Banana suffers a range of production constraints including pests, especially banana weevils (*Cosmopolites sordidus* Germar) and root nematodes, diseases, particularly black sigatoka (*Mycosphaerella fijensis*), Fusarium wilt, bacterial wilt, frequent droughts and reduced soil fertility (Gold *et al.*, 1993; Talwana *et al.*, 2003; Tushemereirwe *et al.*, 2004). These factors cause significant yield losses and shorten the plantation lifespan.

Breeding for disease-resistant banana cultivars using classical methods remains a tedious endeavour because of high sterility, polyploidy, and long generation times of most of edible cultivars (Arinaitwe, 2008). Genetic transformation provides an opportunity for

single genes of interest to be extracted from the genome of the source organism and transferred directly into the genome of the desired variety. This allows the candidate variety to retain all its original characteristics, with only simple addition of the desired trait (Sagi *et al.*, 1997).

Among the available DNA delivery techniques, *Agrobacterium*-mediated transformation is widely used due to: (i) the simplicity and low cost of the technique (ii) low copy numbers of the transgene and (iii) ability to transfer large DNA segments with minimal rearrangement (Cheng *et al.*, 2004; Jones, 2005). *Agrobacterium* has been used to transform several banana genotypes including but not limited to Grand Nain', AAA. Cavendish, AAA, Rasthali, AAB, lady finger, AAB, 'Three Hand Planty', AAB, 'Obino l'Ewai,' AAB , and 'Orishele', AAB (May *et al.*, 1995; Khanna *et al* 2004; Khanna *et al.*, 2007; Arinaitwe, 2008). However, the low transformation and regeneration efficiencies have been a drawback in banana genetic engineering (Khanna *et al.*, 2004). Refinement of banana transformation protocols has been done through improvement of bacterial contact with the banana cells (Khanna *et al.*, 2004), incubation temperature and plant cell volume (Arinaitwe, 2008). Culturing cells on auxins to stimulate cell division prior to transformation is routinely used but the improvement of the transformation frequency has not been significant (Villemont *et al.*, 1997). Therefore, up regulating genes that directly modulate the cell cycle in order to improve the transformation frequency of bananas need to be explored.

1.2 Statement of the problem

Production of highland bananas, a primary staple food in East Africa, is threatened by several diseases and pests (Gold *et al.*, 1993). Banana breeding for resistance is a very difficult and a slow process especially with conventional means due to the limited sources of resistance, sterility of cultivated bananas, high polyploidy levels, long generation time and lack of rapid screening methods. Sources of resistance occur in land races and wild species but the land races are often sterile and therefore cannot be used in breeding, while crosses involving wild species result in transfer of undesirable traits together with the desired gene (Arinaitwe, 2008). Biotechnology tools, such as genetic transformation, offer a sustainable solution to the problem facing conventional breeding of banana as it allows transfer of potential candidate genes such as those for pest resistance directly into the banana genome without altering the original characteristics of a given cultivar (Kiggundu, 2008). However, genetic transformation and regeneration of transgenics remains low in recalcitrant crops like banana (Khanna *et al.*, 2007). For example, Tripathi *et al.*, (2008) got a regeneration frequency of 10% (In “Sukali ndiizi”). Even where this method is practical, it is often limited to certain cultivars. This has proven to be a major obstacle in developing an efficient transformation technology that can be adapted easily to a wide range of plant genera, species, and cultivars.

Although phytohormones, such as auxins, are powerful tools to stimulate cell division and modify the competence of cells they are often inadequate for promoting efficient transformation and regeneration of transgenic plants (Zuo *et al.*, 2002). The potential uses of *CycD* genes to improve regeneration and as a means to generate marker-free

transgenic plants were summarized. Several opportunities as to how these genes might be harnessed to improve transformation systems were identified (Zuo et al., 2006). However, the evaluation of *CycD2* genes responsible for stimulating plant cell division, which is a major requirement for successful transformation, has not been done in “Sukali ndiizi”. The cultivar “Sukali ndiizi” is important because it is one of the most widely consumed bananas in Uganda and yet the crop yield per acreage is progressively decreasing due to its susceptibility to diseases such as the Banana bacterial wilt.

1.3 Justification of the study

Most banana varieties are sterile, leading to the need for the integration of biotechnological tools into breeding programmes. Gene transfer also offers the possibility to add just a few novel traits without altering the genome of the preferred variety (Kiggundu, 2008).

Before genetic manipulation is applied to a given plant, it is necessary to establish an efficient system for plant regeneration and the method to deliver genes at high frequency suitable for transformation (Khanna *et al.*, 2007). Molecular studies of the cell cycle have revealed the role of *CycD*-type genes as key regulating sub units of the progression of cells to the G1/S transition (Inze and De Veylder, 2000). The *CycD* types are reported to be signal transduction elements of plant growth regulators (Villemont *et al.*, 1997; Menges *et al.*, 2005). Thus, the potential of *CycD* genes in improving genetic transformation had been suggested (Arias *et al.*, 2006). This prospect, however, was not evaluated in bananas whose transformation and regeneration efficiencies are as low as

10% (Tripathi *et al.*, 2008). This study, determined the effectiveness of induced *Arath CycD2* and *Musa CycD2* in increasing transformation and regeneration efficiency of transgenic bananas (cv. “Sukali ndiizi”). The cultivar “Sukali ndiizi” was selected because it is very susceptible to diseases like Banana bacterial wilts hence they need resistance improvement. Its cell suspension can also be easily regenerated compared to other cultivars. A high-efficiency, genotype-independent transformation protocol would be a major advance and would provide a significant boost towards both ongoing efforts to improve the agronomic properties of bananas and their development into “biofactories” for products of industrial importance.

1.4 General objective

To evaluate the effect of *CycD2* genes from *Arabidopsis* and *Musa spp.* on transformation and regeneration efficiency of banana cells, cultivar “Sukali ndiizi”.

1.5 Specific objectives

1. To clone *Arath cycD2* and *Musa CycD2* gene constructs and fuse the prepared constructs with the *UidA* (GUS) reporter gene.
2. To determine the transformation and regeneration of “Sukali ndiizi” embryogenic cells.
3. To evaluate the effect of *Arath CycD2* and *Musa CycD2* transgenes on the transformation and regeneration efficiency of banana (cv.”Sukali ndiizi”).

1.6 Hypotheses

- i). *Arath CycD2* and *Musa CycD2* cannot be integrated into “Sukali ndiizi” genome.
- ii). *Arath CycD2* and *Musa CycD2* does not increase regeneration efficiency in banana cv. “Sukali ndiizi” by at least 20%.
- iii). *Musa CycD2* has less effect on the regeneration efficiency in banana cv. “Sukali ndiizi” compared to *Arath CycD2*.

CHAPTER TWO: LITERATURE REVIEW

2.1 Banana germplasm improvement

Banana improvement involves use of conventional breeding and genetic transformation methods (Figure 2.1). Conventional breeding involves crossing cultivars of different qualities, like good yield and drought resistance, using their pollen to come up with improved varieties. Plant transformation is the introduction of at least two genes, a selectable marker gene and a gene of interest into a host plant cell (Sagi *et al.*, 1997). On the other hand, regeneration is the organogenesis or embryogenesis from the transformed cells (Arias *et al.*, 2006). In summary, genetic transformation of plants will help meet human demands for food, energy, medicine, shelter, clothing, and a cleaner environment.

Selectable marker genes are important and are widely used in transformation because they help both in technological development as well as in the study of foreign gene behavior and integration in plants. The mostly used selectable markers are neomycin phosphotransferase (*nptII*) and Hygromycin phosphotransferase (*hptII*) (Phillipe 2006)

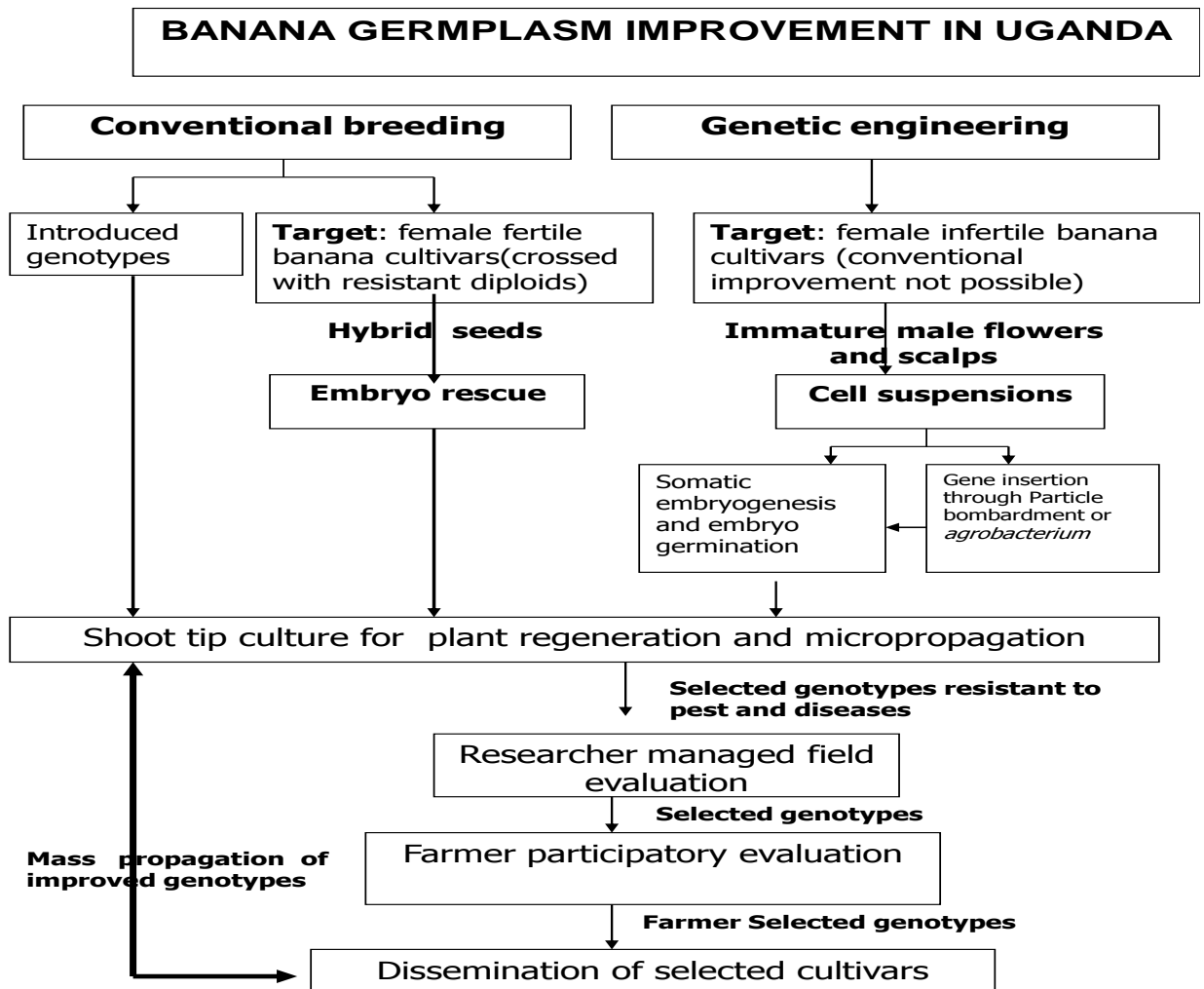

Figure 2.1 Diagrammatic presentations of different methods of plant breeding, regeneration and dissemination of improved cultivars. Note the use of cell suspensions, controlled by the cell cycle, for *Agrobacterium* transformation.

2.1.1 Genetic transformation and regeneration of bananas

All technologies required for genetic engineering of bananas have become available in the last ten years. Male buds were used to generate cell suspensions (Cote *et al.*, 1996). Cryopreservation of these cells has reduced losses by contamination. It has also made the

cells readily available, reducing the need to repeatedly go through the complicated procedure to generate new ones. Several genetic transformation systems have been used for bananas. These include electroporation of protoplast, particle bombardment (Biolistic gun) and *Agrobacterium*-mediated gene transfer (May *et al.*, 1995; Sagi *et al.*, 1995; Ganapathi *et al.*, 2001).

The gene gun is part of the gene transfer method called the biolistic method. In this method, DNA or RNA adheres to biological inert particles i.e. gold or tungsten. By this method, DNA-particle complex is put on the top location of target tissue in a vacuum condition and accelerated by powerful shot to the tissue, and then DNA will be effectively introduced into the target cells. Uncoated metal particles could also be shot through a solution containing DNA surrounding the cell thus picking up the genetic material and proceeding into the living cells (Sagi *et al.*, 1995).

Electroporation is the process where cells are mixed with a DNA construct and then briefly exposed to pulses of high electrical voltage. The cell membrane of the host cell is penetrable thereby allowing foreign DNA to enter the host cell. Some of these cells will incorporate the new DNA and express the desired gene (May *et al.*, 1995).

Among the available DNA delivery techniques, *Agrobacterium*-mediated transformation is preferred due to: (i) the simplicity and low cost of the technique (ii) low copy numbers of the transgene and (iii) ability to transfer large DNA segments with minimal rearrangement (Cheng *et al.*, 2004; Jones, 2005).

2.1.2 *Agrobacterium* mediated transformation

Agrobacterium tumefaciens, a soil inhabiting bacterium that infects a wide range of dicotyledonous plant species, has been utilised to transfer a DNA fragment (T-DNA) into the genomes of a wide range of organisms including bacteria, fungi, plants and even human cells (McCullen and Binns, 2006). Genes of interest inserted into the T-DNA region can be co-transferred and integrated into host genome, as illustrated in figure. 2.2, without disturbing the host endogenous hormone balance (Sagi *et al.*, 1997).

The molecular basis of *Agrobacterium* mediated gene transfer is underpinned by the activities of a large (200kb) Ti plasmid that is resident in virulent *Agrobacterium* strains (Zambryski, 1998). Virtually any DNA fragment cloned within the T-DNA can be transferred into the host plant cell irrespective of its composition and source. Based on this genetic property, the deletion of the T-DNA genes, responsible for tumorigenesis, results into regeneration of a fertile plant that is capable of transmitting the engineered DNA to the progeny. Bacterial colonisation is preceded by host recognition and takes place after the attachment process in a polar fashion (De la Riva *et al.*, 1998). *Agrobacterium* mediated gene transfer method has been widely employed in transformation of bananas (May *et al.*, 1995; Khanna *et al.*, 2004; Arinaitwe, 2008).

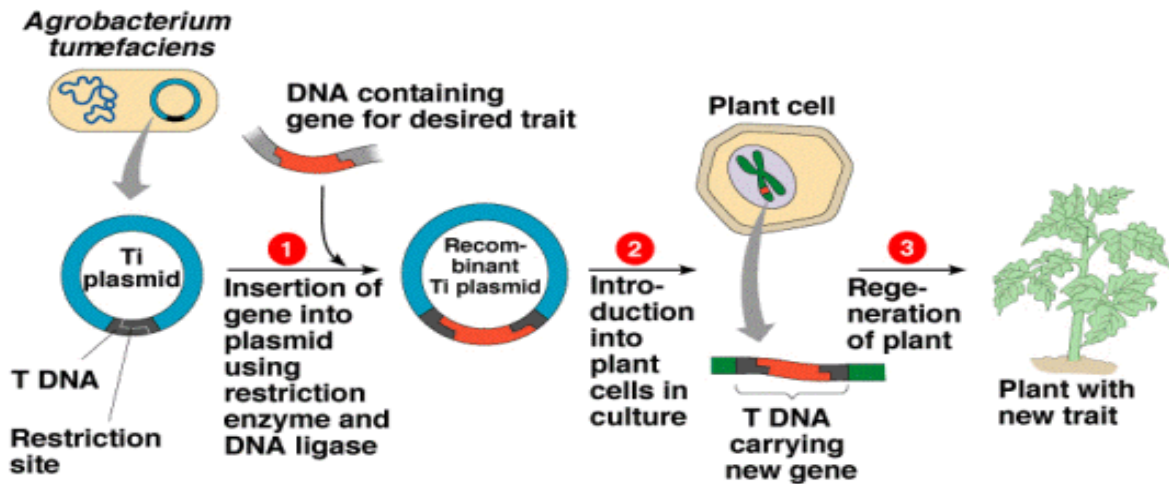

Figure 2.2 An illustration of how *Agrobacterium* can be used to transform plant cells in order to regenerate transgenic plants (Adopted from <http://webschoolsolutions.com/biotech/transgen.htm>)

2.1.3 Factors influencing *Agrobacterium* mediated transformation

Many factors influencing *Agrobacterium* mediated transformation of monocotyledonous plants have been investigated and elucidated. They include plant genotype and explant types, as well as the influence of *Agrobacterium* strains and binary vectors (Carvalho *et al.*, 2004; Cheng *et al.*, 2004; Khanna *et al.*, 2004). In addition, a wide range of inoculation and co-cultivation conditions has been shown to be important for transformation of monocotyledons. These include antinecrotic treatments, using antioxidants and bactericides; osmotic treatments, pre-culture with growth regulators, desiccation of explants before or after *Agrobacterium* infection, and use of surfactants like pluronic acid F68 (Chateau *et al.*, 2000; Cheng *et al.*, 2004; Khanna *et al.*, 2004).

The effects of other physical parameters like infection time and co-cultivation volume were also investigated and shown to increase transformation efficiency but caused post

infection difficulty in selection against excessive *Agrobacterium* (De Clercq *et al.*, 2002). Co-cultivation temperature of 22°C was found to be optimum for banana (Arinaitwe, 2008). *Agrobacterium* cell density during infection, medium, pH, age, size and density of calli during co-cultivation, and the concentration of acetosyringone, all these affect the transformation efficiency (De Clercq *et al.*, 2002). All these reports highlight the importance of thorough optimisation of *Agrobacterium* mediated transformation procedures when dealing with new crops.

2.2 Cell cycle regulation and cell division

The cell cycle is comprised of 4 stages, namely, Gap 1 (G1), Synthesis (S), Gap 2 (G2) and Mitosis (M) (See figure.2.3). The cell cycle phases are defined by an ordered series of events that allow for cell proliferation and lead to the creation of two daughter cells through cell division. At the G1 phase, the cells either prepare for S phase or exit the cell cycle to differentiate (Meredith, 2006). In addition, there is also a restriction point, which assesses the integrity of the DNA prior to replication. After the G1 phase, DNA replication occurs in S phase. At the G2 phase, the cells prepare for the M phase.

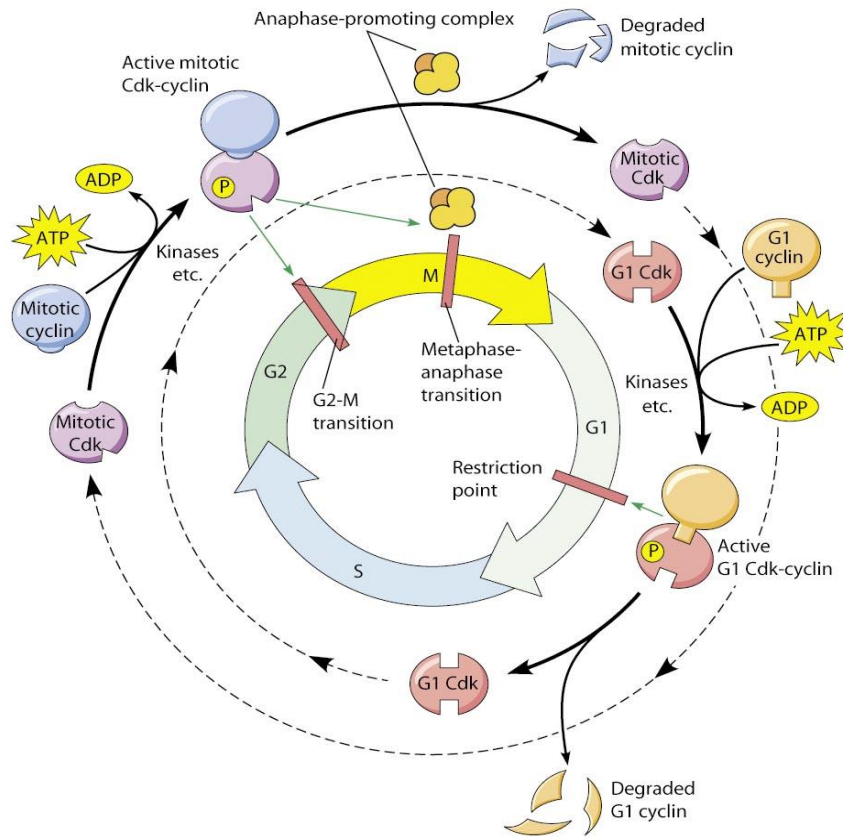

Figure 2.3 An illustration showing phases of the eukaryotic cell cycle. Four major phases are shown where G1 during which the cell grows, S, during which the nuclear genetic information is replicated; G2, when further growth in preparation for division occurs; and M, in which the cellular contents are partitioned between two daughter cells. Restriction points at different phases are also shown (Adapted from <http://www.mun.ca/biology/desmid/brian/BIOL2060/BIOL2060-19/1940.jpg>.)

Just like in the G1 phase, in G2, there is a restriction point. In the presence of unreplicated or damaged DNA, a cell may be arrested to repair the DNA damage, or, may undergo other events that lead to apoptosis (Inze D and Lieven De Veylder., 2006; Khanna *et al.*, 2007). After the G2 phase, nuclear and cytoplasmic division occurs in the M phase, resulting in the creation of daughter cells.

In the presence of mitogenic growth factors, expressions of D-type cyclins (*CycD1*, *CycD2*, *CycD3* and *CycD5*) are stimulated and continue throughout G1 phase as long as the growth factors are present. D-type cyclins form complex with cyclin dependent kinases (CDK) catalytic subunits. However, retinoblastoma protein (Rb), has been shown to constrain cells from progressing through G1 phase of the cell cycle. Retinoblastoma protein forms complexes with many cellular proteins including E2F transcription factors. When in complex with E2F factor, Rb represses transcription from E2F-independent promoters. Upon phosphorylation by the D and A-type cyclins, in association with their cyclin kinase partners, retinoblastoma protein (Rb) releases the E2F factors, thus enabling the G1-S transition to occur (Dewitte *et al.*, 2003). The activity of the G1 cyclins may be blocked by the cyclin-dependent kinase inhibitors (CKIs), which belong to the p21 and p16 families of proteins (Smits and Medema, 2001).

2.3 The effect of *CycD* genes and G1-S transition on regeneration of plants

The control of the G1-S transition is crucial to the commitment to further cell division or differentiation in eukaryotic cells. G1/S transition is driven by the E2F-RBR pathway where E2F is a family of transcription activators that are normally repressed in differentiated cells by Retinoblastoma related protein (RBR) and are upregulated before entering S phase. Upon phosphorylation by D Cyclins, in association with their kinase partners, RBR releases the E2F factors, enabling the G2-S transition to occur (Shen, 2001; Dewitte and Murray, 2003)

Transformation and regeneration efficiency has been positively associated with cells whose nuclei are at the S phase of the cycle (Villemont *et al.*, 1997; Lai and Chen, 2002; Pena *et al.*, 2004). This is because the G1 control in plant cells is a major decision point in the cell cycle and cells that pass through this point are committed to complete a full cycle leading to mitotic cell divisions. The plant cell DNA repair machinery is also more active during cell division due to on-going DNA replication processes (Tzfira *et al.*, 2002). It also well is established that actively dividing cells are prone to uptake of foreign DNA (Dewitte *et al.*, 2003).

Over-expression of *Arath CycD2* gene has been shown to significantly increase seedling growth and development in rice (Se-Jun *et al.*, 2008). Moreover, ectopic expression of *Arath CycD2* in transgenic tobacco (*Nicotiana tabacum*) and *Arabidopsis thaliana* plants led to accelerated development and a faster growth rate attributable to a reduction in cell cycle length caused by a reduced G1-phase duration (Cockcroft *et al.*, 2000). Generally, *CycD2* is present in exponentially growing cells and is strongly reduced in stationary phase cells (Gaudin *et al.*, 2000; Dewitte *et al.*, 2007). Different *cyclinDs* function in separate pathways but increased *CycD2* levels appear to promote cell division (Dewitte and Murray 2003). In cells progressing through the cell cycle, *CycD2* is induced very early in G₁ phase. Interestingly, continued expression of *CycD2* requires sucrose but is independent of the presence of hormones (Pena *et al.*, 2004).

Several studies have attempted to investigate the factors affecting *Agrobacterium* mediated transformation (Khanna *et al.*, 2004, Arinaitwe, 2008). However, little was

achieved to solve the problem of low transformation and regeneration efficiencies, especially in recalcitrant plants like banana. The potential of *CycD* genes to modulate the cell cycle as a strategy to increase the competency of cells for transformation and regeneration was proposed by Arias *et al.* in 2006. Studies described in this dissertation, therefore, determine if *CycD2* from both *Arabidopsis* and *Musa spp.* could improve the competence of “Sukali ndiizi” cells for the uptake of important foreign genes.

2.4 Reporter genes

There are several ways of determining where and when a particular gene is expressed in a plant. The best way of achieving this is the use of a reporter gene. A reporter gene produces a protein that is easily detectable in the transformed organism. Often, the protein possesses an enzymatic activity that can turn a colorless substrate into a colored product. Thus, one can see the location and amount of gene expression in a transformed organism by looking at the location and intensity of the colored product. Widely used reporter genes in transgenic plants are *uidA* gene coding for β -glucuronidase (GUS) from *E. coli* (Jefferson, 1987) and *gfp* gene from jelly fish, *Aequorea victoria* (Eliot *et al.*, 1999) coding for green fluorescent protein (GFP). When the reporter gene is fused to the promoter of the gene of interest, the reporter gene will be expressed only at the times and locations where also the gene of interest is expressed. This provides a method to detect a very limited expression of a gene. The most important property of reporter genes is that their activity is absent in the organism in which they will be used.

CHAPTER THREE: MATERIALS AND METHODS

3.1 Experimental site

The study was carried out at the National Agricultural Research Laboratories, Kawanda, in the biotechnology laboratory which constitutes of tissue culture and molecular biology sections. Kawanda (0°25'N, 32°32'E) is 13 km north of Kampala city and 1195m above sea level.

3.2 Vectors and bacteria manipulations

3.2.1 Cloning of *Arath CycD2* and *Musa CycD2* gene constructs

The strategy for cloning the *Arath CycD2* and *Musa CycD2* genes in *E.coli* is outlined in Figure. 3.1. Primers (whose names and sequences are shown in table 3.1) were designed with restriction sites for *Bam*HI and *Hind*III to amplify the *Arath CycD2* and *Musa CycD2* using PCR. The amplicon was cloned using a Topo TA cloning kit (Invitrogen from United Kingdom). The Topo vector was restricted using *Bam*HI and *Hind*III enzymes and restriction reaction run on agarose gel to isolate the band of interest. The fragment was purified using Qiaquick gel purification kit (Qiagen, United Kingdom) as recommended by the manufacturer, and ligated in PLBR19 vector that has Cauliflower mosaic virus (CaMV) 35S promoter and terminator. The constructs were transformed into *E. coli* (strain JM109) and selected on LB medium (bacto trypton 10g/L, bacto yeast extract 5g/L, sodium chloride 10g/L and bacterial agar 15g/L (for LB agar), pH 7.0.) containing 100µg/ml of ampicilin. Using enzymes, *Kpn*I and *Xba*I, the genes with the

CaMV 35S promoter and terminator were restricted and ligated into pC1305.1 binary vector containing the *UidA* (GUS) reporter gene.

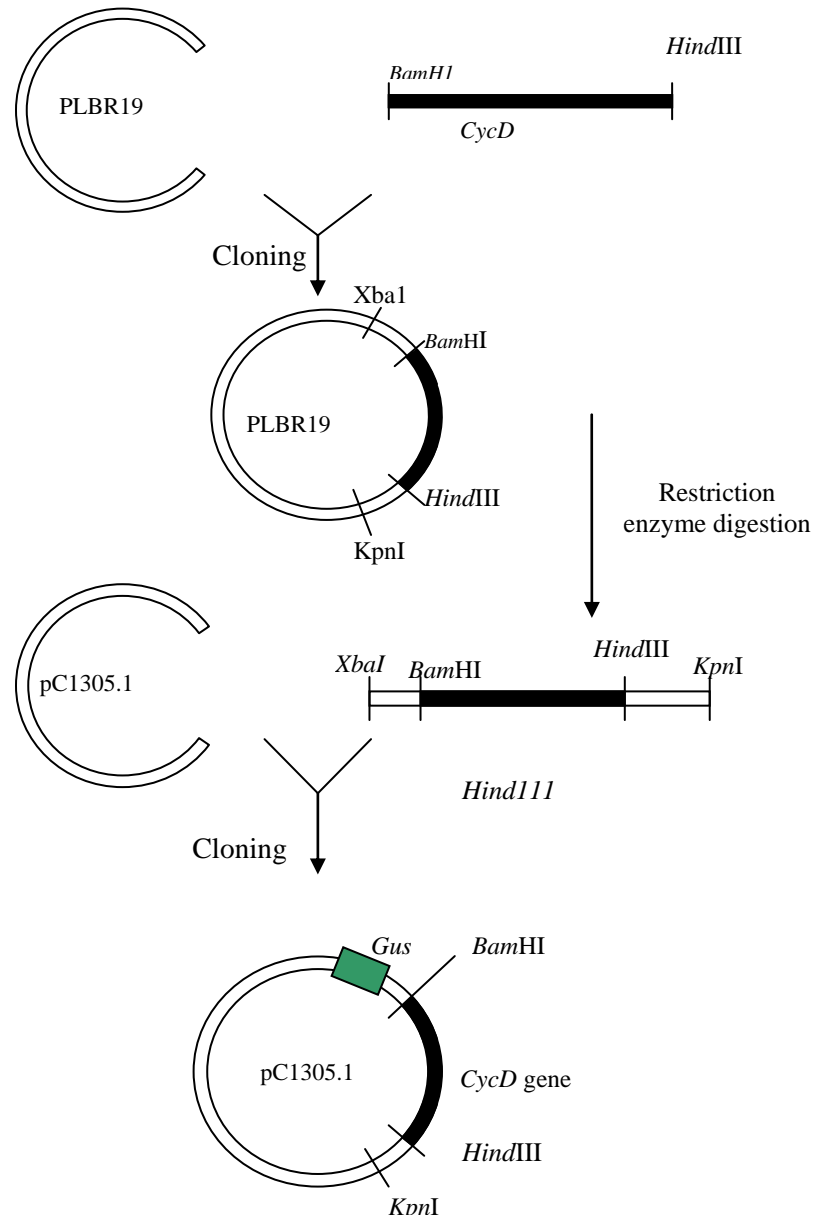

Figure 3.1 Schematic diagrams illustrating the construction of expression vector, pC1305.1 containing *Musa CycD2* or *Arath CycD2* and *Gus* genes, used in the study to express the genes in *E.coli* and *Agrobacterium tumefaciens* accordingly. *CycD* gene is 1kb, PLBR19 vector is 8800 bp and the pC1305.1 vector is 11846 bp.

The resultant gene construct (figure 3.2) in the binary vector, pC1305.1, was transformed into *E.coli* (Strain JM109) by heat shock method and selected on LB medium with kanamycin 100µg/ml. The final gene construct that was finally transformed into ‘Sukali ndiizi’ cells through *Agrobacterium* mediated transformation method.

Three distinct colonies were picked, grown overnight in LB liquid medium at 200 rpm and plasmid was extracted, using the Qiaprep miniprep kit (Qiagen-United Kingdom), according to manufacturer’s instructions. At all stages, PCR, restriction digestion and gel electrophoresis were done to confirm the presence of inserts in respective vectors.

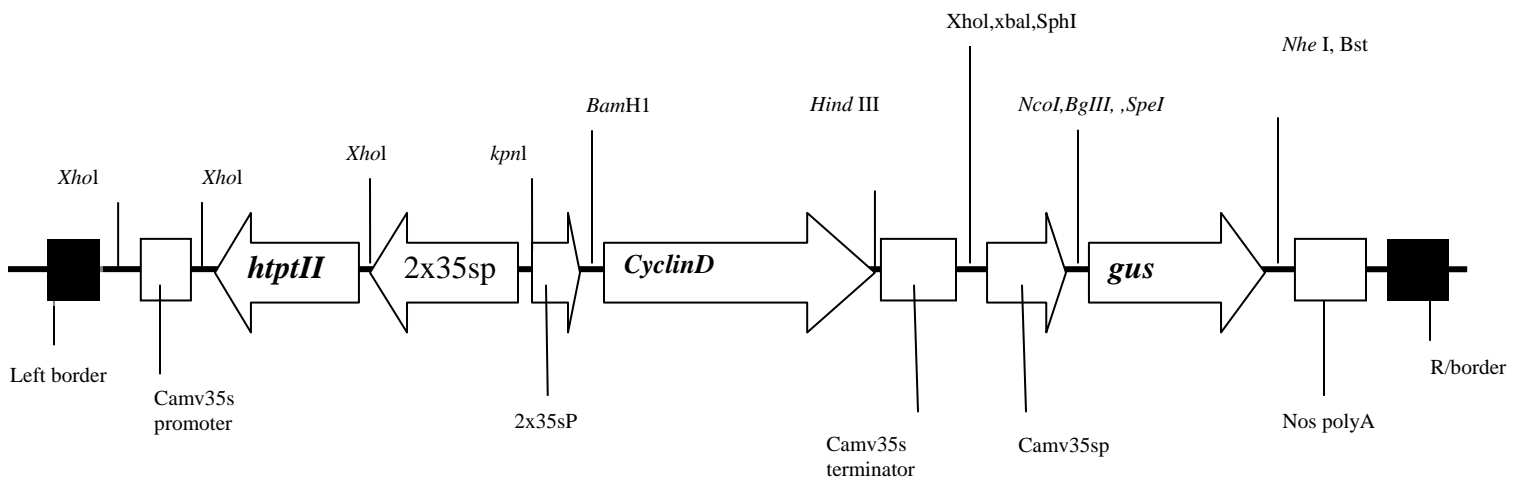

Figure 3.2 Vector map for gene construct with *Musa CycD* or *Arath CycD2*, *hptII*, and GUS genes fused together. The genes are driven by the 35S CaMV promoter. Different restriction enzymes used in restriction digestions are shown as well as direction of expression of the genes in the plant cell.

The restriction digestion reaction used to detect recombinant *E.coli* was composed of 5.8 µl of water , 2 µl of 10X Tango buffer, 1 µl *HindIII* (20U/µl), 1 µl *BamHI* (20U/µl) and 0.2 µl of 1x BSA. The same volume of enzymes and buffers were used for the case of

KpnI and *XbaI* (New England Biolabs® Inc.). Agarose 1% was used to run all gels in 1x TAE pH 8.0. The gels were run at 120 volts for 1 hour and then stained in ethidium bromide solution (0.5µg/ml) for 15 minutes.

3.2.2 Preparation of competent bacterial cells and plasmid purification

Bacterial cultures were plated on different medium. For *E.coli* (strain JM109) cultures, LB medium was used. *Agrobacterium tumefaciens* (Strain AGL-1) was incubated for 3 days on solid yeast-mannitol (YM) medium (0.4 g/L Yeast extract, 10g/L mannitol, 0.5g/L K₂HPO₄, 0.2g/L MgSO₄, 0.1g/L NaCl) pH 6.8. No antibiotics were used.

For the preparation of competent cells of *A. tumefaciens*, 100ml of fresh medium were inoculated with 5 ml of overnight culture. At OD₆₀₀ = 0.5-0.7 cells were harvested by centrifugation at 6000 rpm for 10 minutes at 4°C. Cell pellets were washed twice in 10 ml ice cold Milli-Q water centrifuged as above and supernatant discarded. The pellets were gently re-suspended in 10 ml of ice cold 20% (v/v) glycerol solution in Milli-Q Water, centrifuged as above for 10 minutes at 4°C and supernatant discarded. The pellets were gently re-suspended in 100µl of ice cold sterile 20% (v/v) glycerol solution. The aliquots were pre-cooled in eppendorf tubes, flashed in liquid nitrogen and stored at -80°C.

For *E. coli* competent cells, a single colony was inoculated in 5ml of liquid LB medium and incubated overnight at 37°C and 200 rpm. One hundred micro litres of the overnight culture was inoculated in 100ml of fresh LB broth and incubated at the same conditions. The culture was placed on ice in sterile falcon tubes for 10 minutes and centrifuged for 10 minutes at 8000rpm and the pellet re-suspended in 10ml CaCl₂ solution (60 mM CaCl₂,

20% glycerol, pH 7.0). Aliquots of 100µl in eppendorf tubes were flashed in liquid nitrogen and stored at -80°C for future use.

3.2.3 Transformation of competent *E.coli* cells and Plasmid purification

An aliquot of competent *E.coli* cells (100µl) were placed on ice for 30 minutes. Plasmid DNA (5µl) was added to the competent bacteria, the tube was tapped gently and the mixture incubated for 30 minutes on ice. The tubes were placed in 42°C water bath for 45 seconds and placed back on ice for 2 minutes. Five hundred micro litres of LB medium was added to the transformation mix and the bacteria was incubated for 2 hours at 37°C and 200 rpm to allow recovery of cells from the heat shock and start expression of the selectable marker gene. After 2 hours of incubation, 100µl of the culture was spread on selective LB agar containing ampicilin (100µg/ml) for PLBR19 vector and Kanamycin (100µg/ml) for pC1305.1 vector and incubated overnight at 37°C.

Single bacterial colonies were picked and cultured in 5ml of selective LB medium (containing Kanamycin, 100µg/ml). Cultures were incubated at 37°C with shaking at 200rpm overnight. Plasmid isolation was done with the QIAprep spin Miniprep Kit reagents following manufacturer's instructions (Qiagen-United Kingdom). Briefly, the 5ml cultures were centrifuged at 6000rpm for 10 minutes and the supernatant discarded. The pelleted bacterial cells were re-suspended in 250µl of P1 solution. Buffer P2 (250ul) was then added to lyse the bacterial cells. After gently inverting the tube four times, proteins and polysaccharides were precipitated by the addition of 350µl of N3 buffer. This was followed by centrifugation at 13,000rpm for 10 minutes after which plasmid

DNA in supernatant was loaded onto QIAprep spin column and centrifuged for 1 min at 13000 rpm. The column was washed with buffers PB (500µl) and PE (750µl) by centrifugation at 13000rpm for 1minute, in each case. To elute plasmid DNA, 50µl of sterile water pre-warmed at 70°C was added. The column was placed into a 1.5 ml microfuge tube, left to stand for 5 minutes, and centrifuged at 13000rpm for 1 minute. The isolated plasmid DNA was stored at -20°C for future use. Buffers, P1, P2, N3, PB, PE and columns were supplied in the kit (Qiagen).

3.2.5 Transformation of competent *Agrobacterium* cells

The plasmid vector (DNA) (1µg) containing *CycD2* constructs was added to 100µl of competent *Agrobacterium tumefaciens* (strain AGL-1) cells. The mixture was incubated on ice for 30 minutes with gentle mixing after which it was frozen in liquid nitrogen for 2 min and then thawed for 2 min in water bath at 37°C. The LB medium (500µl) was added and the cells incubated at 28°C for 4 hours at 200rpm. The cells were spun for 1 minute at 8000 rpm, excess supernatant discarded to leave 100µl for re-suspending the pellet. The transformed bacteria were spread on YMA medium containing 250µg/ml carbenicilin, 25µg/ml rifampicin, and 100µg/ml kanamycin. A plate of no transformed AGL-1 cells on selection was included as a negative control.

3.3 Transformation of “Sukali ndiizi” cells

The centrifugation assisted *Agrobacterium*-mediated banana transformation protocol of Khanna *et al.*, (2004) was used. A single colony of *Agrobacterium* containing the

construct was grown for 3 days in 5ml of YMB medium containing carbenicillin 250µg/ml and rifampicin 25µg/ml. The five millilitres were transferred to 20ml of LB medium with the same antibiotics and grown at 28°C at 200rpm for 24 hours. The bacteria suspension was centrifuged at 6000rpm for 10 min at 25°C and the pellet re-suspended in BRM medium (Macro 1/10, Micro (full strength), Iron (full strength), MS vitamins 103g/L, sucrose 85.5g/L thiamine 45mg/L, cystein 2g/L, glucose 180g/L, pH 5.3) containing 400µM acetosyringone (AS) and 0.02% pluronic acid and incubated at 25°C for 2hr shaking at 70rpm. At the end of 2hrs, the O.D was adjusted to 0.6.

Embryogenic “Sukali ndiizi” cells, obtained from cell suspension group at Kawanda tissue culture laboratory, was sub-cultured into fresh M2 medium (MS salts 4.3g/L, biotin 1mg/L, MS vitamins 103m/L, 2,4-D 1mg/L, glutamine100mg/L, malt extract 100mg/L, Sucrose 45g/L, ascorbic acid 60mg/L, pH 5.3) (Cote *et al.*, 1996). The cells (500µl settled cell volume) were infected with induced *Agrobacterium tumefaciens*. The banana cells-bacteria mixture was centrifuged at 900 rpm for 3 minutes at 27°C twice and allowed to rest at room temperature for 30 minutes. The cells were aspirated on sterile nylon mesh and incubated on co-cultivation medium, BCCM (MS salts 4.3g/L, biotin 1mg/L, malt extract 100mg/L, glutamine 100mg/L, proline 230mg/L, ascorbic acid 20g/L, PVP 5g/L, L-cysteine, IAA 1mg/L, NAA 1mg/L, 2, 4–D 4mg/L, sucrose 85.5g/L, pH 5.3, phytigel 14g/L) at 22°C for 5 days.

3.4 Selection and regeneration of “Sukali ndiizi” transgenic plants

After 5 days of co-cultivation, infected embryogenic cell suspensions (ECS) were washed with liquid M2 medium supplemented with Timentin at 200ug/ml. Infected ECS were

sub-divided and aspirated on nylon mesh. The mesh with embedded cells was transferred to semi-solid M3 media supplemented with Timentin (200µg/ml) to kill off bacteria and hygromycin (50µg/ml) to select for transformed cells. The cells were transferred onto selective M3 medium (SH salts 3.2g/L, MS vitamins 103.1g/l, biotin 1mg/L, malt extract 100mg/L, glutamine 100mg/L, proline 230mg/L, myo-inositol, citric acid 60mg/L, ascorbic acid 60mg/L, PVP 10g/L, L-cysteine 400mg/L, NAA 0.2g/L, zeatin 0.2mg/L, kinetin 0.4mg/L, 2-IP 0.2mg/L, Sucrose 45g/L, lactose 10g/L, phytigel 3g/L, pH 5.8) on 50µM nylon mesh every two weeks until observation of embryogenic cell clones (about three months). The cell clones were individually transferred onto selective semi-solid embryo initiating medium (RD1) (MS salts 2.15g/L, MS vitamins 103g/L, ascorbic acid 40mg/L, myo-inositol 100mg/L, sucrose 30g/L, phytigel 2.3g/L, pH 5.8) containing timentin (200mg/L) and hygromycin (50mg/L) for embryo initiation medium. This was followed by transferring the cells onto shoot germination medium (M4) (MS salts 4.3g/l, Morel vitamins 2ml, 6-BAP 0.05 mg/L, IAA 0.2 mg/L, Sucrose 30mg/L, phytigel, pH 5.8) (Murashige and Skoog, 1962). The germinated shoots were grown on proliferation medium in the tissue culture laboratory and subjected to further analysis.

3.6 Molecular characterization of “Sukali ndiizi” transformants

3.6.1 DNA isolation from “Sukali ndiizi” plants

Total DNA was extracted from fifty (50) randomly selected transgenic plants per treatment and five for untransformed controls. Leaf tissues (30mg) of transformed plants and untransformed controls were used to extract the DNA using the modified miniprep protocol of Dellaporta *et al.*, (1983). The DNA pellet was re-suspended in 20µl of Milli-

Q water containing 1mg/ml RNase, treated for 15 minutes at 37°C. The DNA was used directly in PCR analysis or stored at -20°C for future use. Gel electrophoresis and staining using ethidium bromide followed to ascertain the quantity and quality of the DNA before PCR analysis. Since the concentration was high (as shown on the gel in figure 4.8), the DNA was diluted tenfold before use. The preparations of the buffers used during the extraction are described in appendix 2 and 3.

3.6.2 PCR analysis of “Sukali ndiizi” regenerants

The DNA was analysed using PCR to detect the presence *Hygromycin B phosphotransferase (hpt)* selectable marker and the *CycD2* genes. Using specific primers, whose sequences are shown in table 3.1. Segments of *CycD2* (1000bp) and *hpt* (500bp) coding sequences were amplified. Amplifications were performed using Eppendorf Master Cycler (EP-AG 5341 012727, H Hamburg, Germany). The PCR reaction contained 20ng of plant DNA 1.2mM MgCl₂, 0.4µM of each of the primer pairs, 1x PCR buffer, 0.24mM dNTPs and 0.02 Unit DNA polymerase/reaction of 20µl. The primers were designed using an online primer designing software (Primer 3, version 0.4.0, <http://frodo.wi.mit.edu>; Andreas (2007)). The reaction mixture was subjected to an initial denaturation step of 94°C for 3 minutes followed by 35 cycles of 94°C for 30 seconds; annealing temperatures of 60°C for *hpt* and 62°C for *CycD2* for 1 min; Initial extension of 72°C for 1 min and a final extension step of 72°C for 10 minutes. The plasmid vectors were included as PCR positive controls as well as two negative controls (Water to check the PCR false positives and untransformed plant DNA to check the validity of the sample results). The PCR product was run on 1% agarose and gel in TAE buffer (Described in

Appendix 4) using Bio-Rad sub-cell GT electrophoresis system and pictures captured with gel documentation system (G:Box EF² Syngene- United Kingdom).

Table 3.1 Primers used, their sequences, annealing temperature and expected band sizes. FW stands for forward primer and RV stands for Reverse primer.

Primer name	Sequence	Melting temp.(°c)	Band size (bp)
<i>Arath CycD2 FW</i>	5'-CCCAACTTATGAGTCCAAGTT-3'	64	1000
<i>ArathCycD2 RV</i>	3'-CGCGGATCCTCATCTGGTTGT-5'	66	1000
<i>Musa CycD2 FW</i>	5'-CCCAAGCTTATGGCGATTTCG-3'	62	1000
<i>Musa CycD2 RV</i>	3'-CGCGGATCCTTATGGATGG-5'	60	1000
HYG-FW	5'-CTATCGGCGAGT ACT TCTACA CAG-3'	60	500
HYG-RV	3'-CCCATGTGTATCACTGGC AAA C-5'	64	500

3.7 Data analysis

The transient transformation efficiency was expressed as the average number of blue spots counted on three plates for every treatment. The antibiotic resistant colonies and then regenerating shoots out of the total number of colonies plated were quantified. PCR was conducted on genomic DNA from leaves of plants regenerated invitro and the numbers of PCR positive plants out of the regenerated plants were also computed. Microsoft Excel soft ware was used for generating the required graphs and for organizing the data and gen stat 12.0 software was used for ANOVA to generate means and P values at significance level of 0.05.

CHAPTER FOUR: RESULTS

4.1 Cloning of *Arath CycD2* and *Musa CycD2* genes

PCR and restriction digestions of plasmids to confirm the presence of the cloned gene construct prior to transformation of “Sukali ndiizi” cells were done as described in section 3.2.1. Restriction enzymes used included *Bam*HI, *Hind*III, *Kpn*I and *Xba*I. After double digestion of Topo (cloning vector) with *Hind*III and *Bam*HI, fragments of expected band sizes (4kb vector backbone and 1kb for *Arath CycD2* and *Musa CycD2*) were obtained (See fig. 4.1 A).

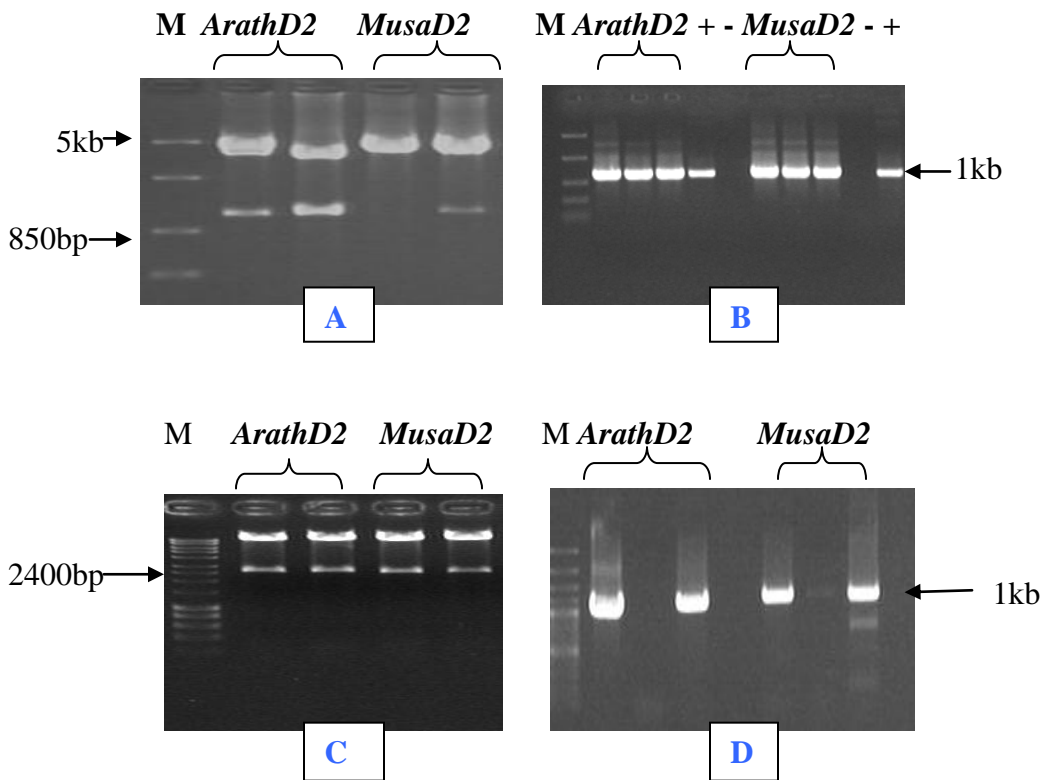

Figure 4.1 Agarose gel electrophoresis of PCR and restriction of plasmid DNA on a 1% agarose gels **A.** Restriction of Plasmid DNA from putatively transformed *E. coli* using *Bam* HI and *Hind*III enzymes. **B.** PCR of the inserts in PLBR19 vector containing the promoter and the terminator. **C.** Restriction digestion of pC1305.1 binary vector using *Kpn*I & *Xba*I enzymes to confirm the presence of the inserted constructs containing the promoter and terminator. **D.** PCR of plasmid extracted from AGL-1 after inserting the gene constructs.

The restriction digestion of PLBR19 (data not shown) and pC1305.1 (Figure 4.1 C) with *KpI* and *XbaI* gave expected band size of 1919bp and 9446bp respectively for the backbones and that of 2400bp for the insert.

PCR using gene specific primers (*Arath cycD2* and *Musa CycD2* primers) on *E. coli* plasmid with pC1305.1 containing insert and *Agrobacterium* plasmid with same insert also gave expected bands on electrophoresis gels as shown in figure 4.1 B and D. The results indicated that the binary vector pC1305.1 which had *Uida* (GUS) reporter gene carried the genes of interest, *Arath CycD2* or *Musa CycD2*, in both *E.coli* and *Agrobacterium*.

4.2. Transformation and regeneration of “Sukali ndiizi” embryogenic cells with *Arath CycD2* and *Musa CycD2*

4.2.1 Histochemical GUS assay of transient *CycD*-GUS gene transformed banana cells

Using *Agrobacterium* mediated transformation system, ECSs of banana cultivar “Sukali ndiizi” was co-cultivated with AGL-1 strain harbouring a binary vector pC1305.1 carrying *Arath CycD2*, or *Musa CycD2* genes. Samples were selected randomly and histochemically stained using gus stain (preparation shown in appendix 1) for the expression of GUS gene (figure. 4.2).

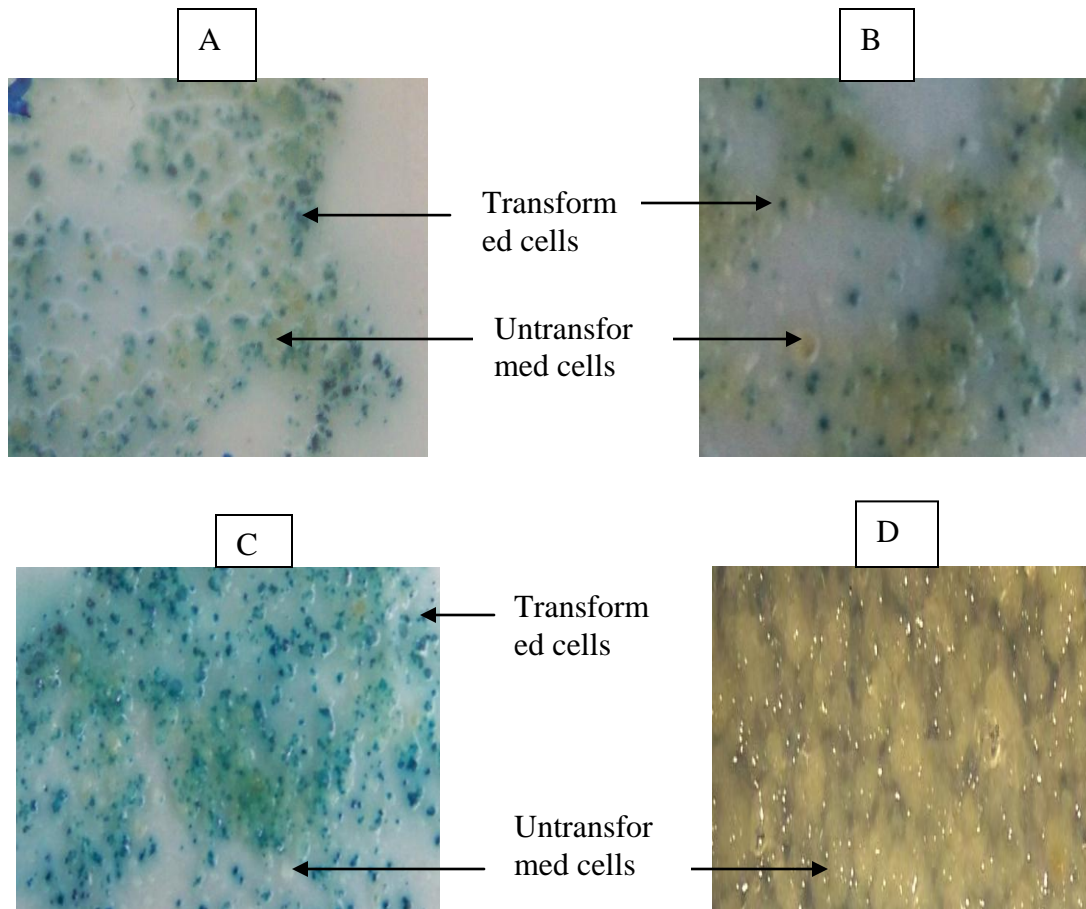

Figure 4.2 Histochemical assay for transient expression of GUS gene in “Sukali ndiizi” ECS transformed with different *CycD*–*GUS* gene after overnight incubation at 37°C. **A.** *Arath CycD2*. **B.** *Musa CycD2*. **C.** Control with only pC1305.1 vector without *CycD2* gene. **D.** Non transformed control. The blue spots indicate transformed cells. The non stained cells are not transformed and resemble those in control (D).

To effectively compare gene transformation efficiency associated with the two *CycD2* genes, quantitative analysis of blue foci (Transformed cells) obtained by histochemical GUS assay of transformed ECS cells was performed. The GUS assay, expressed as the average number of counted blue spots per treatment, was observed to be 155, 81 and 171 for *Arath CycD2*, *Musa CycD2* and control (Binary vector only), respectively. Three randomly selected plates were counted and each plate contained 100µl of PCV of cells. Though there was no statistical difference ($p \leq 0.166$) among the different genes, the

general intensity of the blue foci was higher than what is always observed in other transformation experiments at Kawanda biotechnology center (National banana research programme un-published data).

4.2.2 Selection and regeneration of “Sukali ndiizi” transformants

Transformed ECSs were transferred to selective M3 media and incubated in the dark at $25\pm 2^{\circ}\text{C}$ for 3 months. After three weeks in culture, the ECSs turned brown due to necrosis and massive death of untransformed embryogenic cells. One month later, numerous whitish cell clumps (embryogenic cell colonies) appeared on the surface as shown in figure 4.3. This response occurred in all treatments except in negative control. The embryogenic colonies (white) were quantified in ten replicates per treatment to determine how many transformed cells resisted selection. A hundred randomly selected colonies per construct were then transferred to selective RDI medium (Figure 4.4) for embryo development (for one month) from which they were transferred to M4 medium for regeneration. The colonies began to germinate 3 weeks later (Figure 4.5). The regenerated shoots were cultured on proliferation medium and incubated in the light to allow shoot and root formation and development (Figure 4.6). Gus assay was done on different tissues of selected plants (Figure 4.8) to check if the genes were expressed in all parts of the transgenics. DNA was then isolated from randomly selected plants (Figure 4.9) followed by PCR analysis (Figure 4.10) to establish those plants which could amplify with *CycD2* primers as well as plant selectable marker gene (*hptII*).

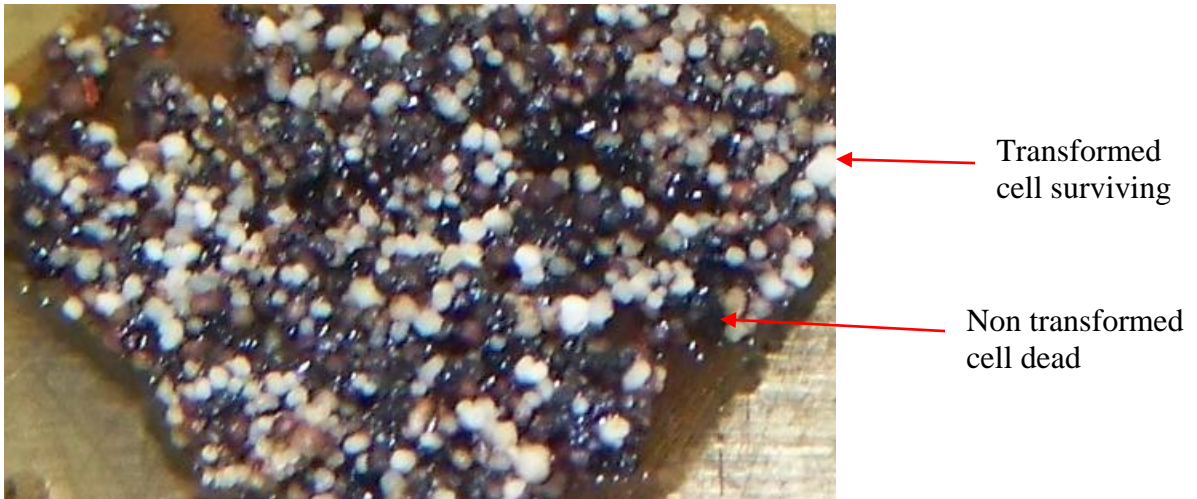

Figure 4.3 Three months cultures of ‘Sukali ndiizi’ transformed cells on selective M3 medium with black dying cells and persisting white cells resistant to hygromycin.

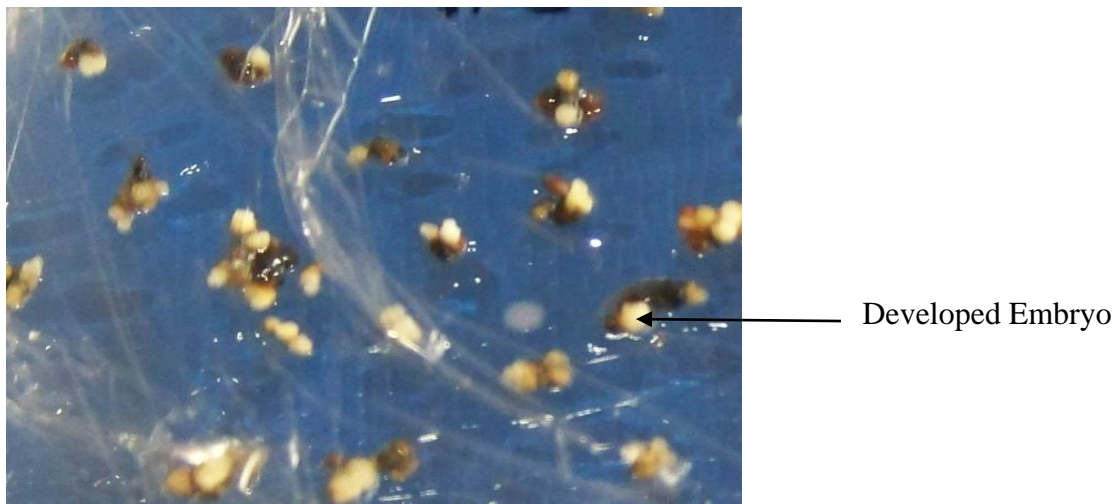

Figure 4.4 Surviving embryos from “Sukali ndiizi” cells, four months after transformation developing on selective RDI medium.

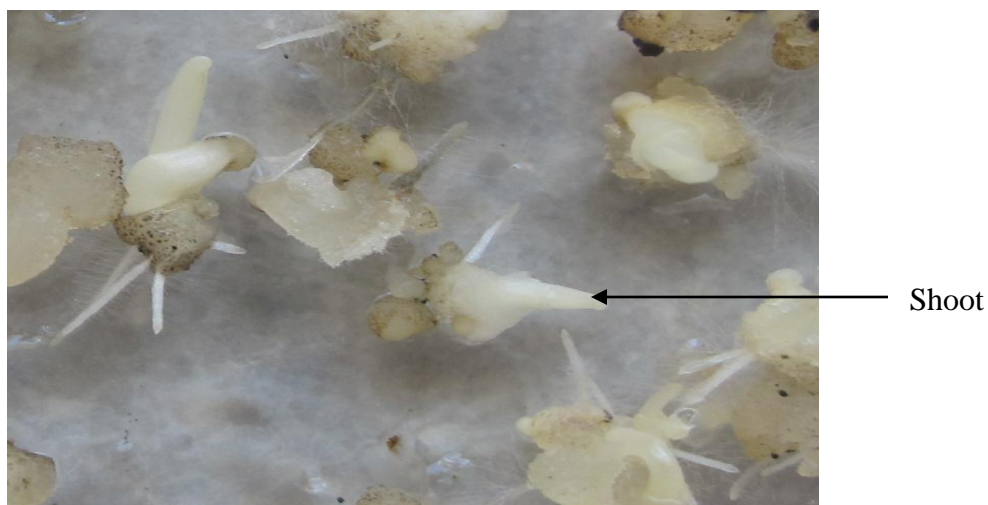

Figure 4.5 Shoots of “Sukali ndiizi” germinating from selective M4 medium. The shoots are five months after transformation.



Figure 4.6 One month old germinated shoots of “Sukali ndiizi” growing on non-selective regeneration medium in the presence of light.

Significant differences (as shown in table 4.1) in the number of surviving clones of cells transformed with *CycD2* ($p \leq 0.001$) as well as regenerated plants ($p \leq 0.001$) were observed. The un-transformed control had 89% regeneration. Cells transformed with *Arath CycD2* or *Musa CycD2* had higher numbers of surviving embryos (1043 and 801) respectively as well as regenerated plants (62% and 47% respectively) compared to the

cells transformed with only pC1305.1 (containing only GUS gene but without the cell cycle gene) that had only 18% regeneration. It was however noted that there was no significant difference ($p \leq 0.166$) between the colonies and shoots regenerated in the *CycD2* genes from *Arabidopsis* and *Musa spp.* More importantly, it was observed that even though the control, with the vector only, scored the highest average number of blue spots per plate (171), it had the least number of regenerants (18%). On the other hand, *Musa CycD2* had the least average number of blue spots (transformed cells that took up the gus stain) per plate, but the number of regenerated shoots were far higher (almost the same as its counterpart from *Arabidopsis*) than those of the control with the vector only.

Table 4.1 Enhanced transformation in “Sukali ndiizi” using *CycD2* genes

Gene type	Number of embryos/0.5 PCV	Shoots/100 embryos	Regeneration frequency	Plant estimate/0.5 PCV
<i>Arath CycD2</i>	1043	62	62%	647
<i>Musa CycD2</i>	801	47	47%	376
pC1305.1	96	18	18%	26
Untransformed	2100	89	89%	8900

NB: Regeneration efficiency is the number of regenerated shoots divided by the number of embryos cultured multiplied by 100.

4.3 Characterisation of “Sukali ndiizi” transgenic lines

4.3.1 Histochemical GUS assay of transformed lines

Different tissues (leaves, corms and roots) were tested and intense blue staining was readily observed in all the positive plants tissues and no staining in control tissues as shown in figure 4.7 below.

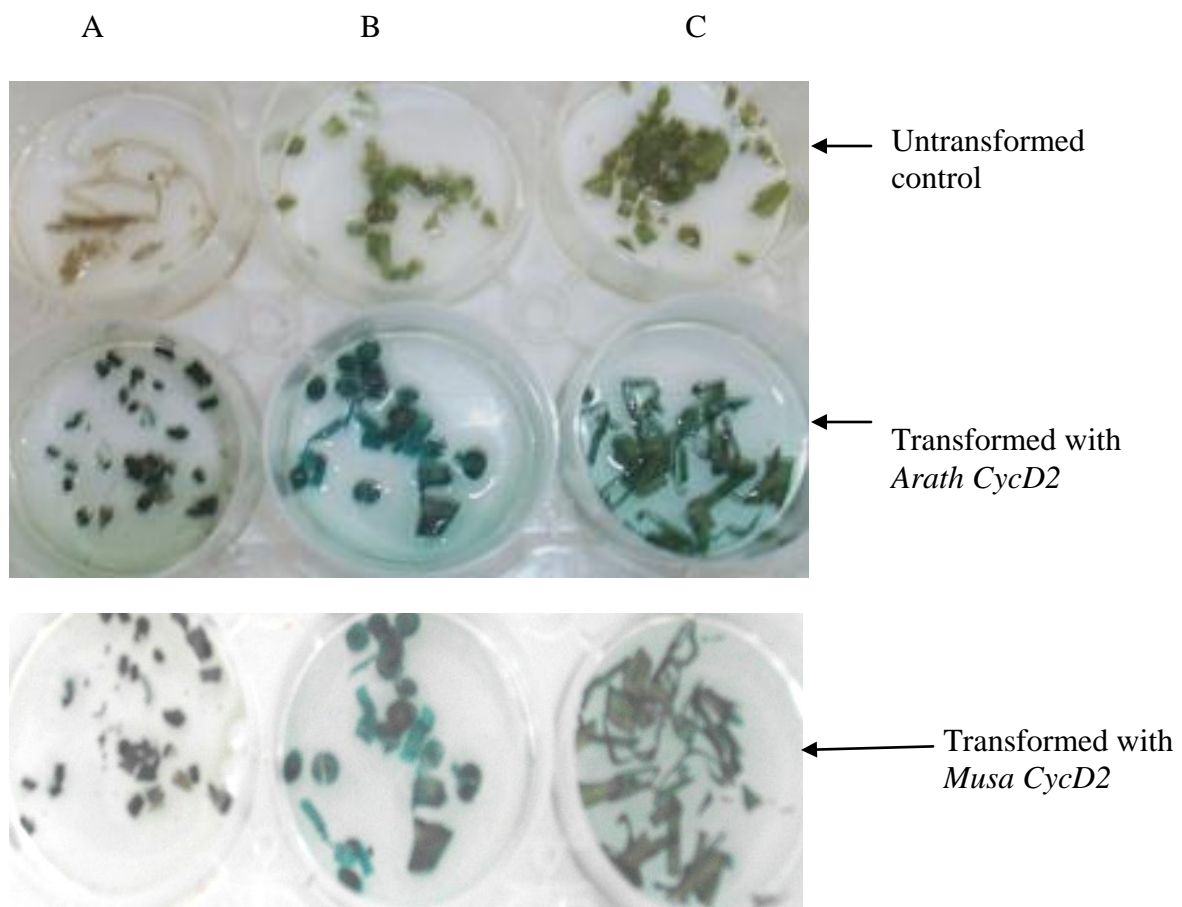

Figure 4.7 Histochemical GUS assay of pieces of root (A) corm (B) and leaf (C) of “Sukali ndiizi” transgenic plants. There was no significant variation in the staining pattern of different tissues.

4.3.2 DNA extraction from “Sukali ndiizi” plants

Total DNA was extracted from fifty (50) randomly selected transgenic plants per treatment and five for untransformed controls. Gel electrophoresis and staining using ethidium bromide followed to ascertain the quantity and quality of the DNA before PCR analysis. Since the concentration was high (Figure 4.8), the DNA was diluted tenfold of which 2µl was used for PCR analysis.

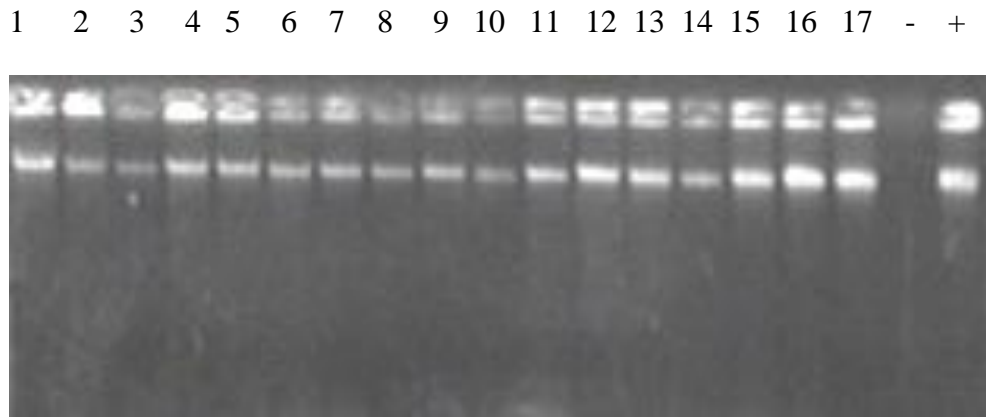

Figure 4.8 Agarose gel for DNA quality and quantity determination. Each well was loaded with 2µl of DNA plus 1µl of 6x loading dye and 3µl of sterile water. The well with negative sign was empty whereas the one with a positive sign had lambda DNA of 0.5µg/ml.

4.3.3 PCR analysis of “Sukali ndiizi” regenerants

While PCR analysis does not confirm stable transgene integration, it is an initial indicator of the presence of these transgenes in the host plant genome. The presence of the *CycD2* gene in the hygromycin resistant plants was shown by PCR analysis. Amplification by *hptII* primers produced expected product sizes of 500bp and *CycD2* specific primers gave expected product size of 1kb for both *Arath CycD2* and *Musa CycD2* corresponding to the internal fragment of the *CylcinD2* gene (Figure 4.9). Of the fifty randomly selected

plants, 74% and 78% for *Arath CycD2* and *Musa CycD2* respectively, had positive amplification of both *hptII* and *CycD2* genes. The control which had empty vector, pC1301.5, without *CycD2* gene had 88% amplification for *hptII* gene. The few lines that did not amplify for *CycD2* genes did not also amplify for *hptII* primers, indicating that they were escapes because they survived selection but they neither had amplification with *CycD2* nor selectable marker gene (*hptII*) which is responsible for resistance (Arinaitwe, 2008). No amplified product was observed in case of the non-transformed plants (negative control) and the PCR negative control (water) as expected.

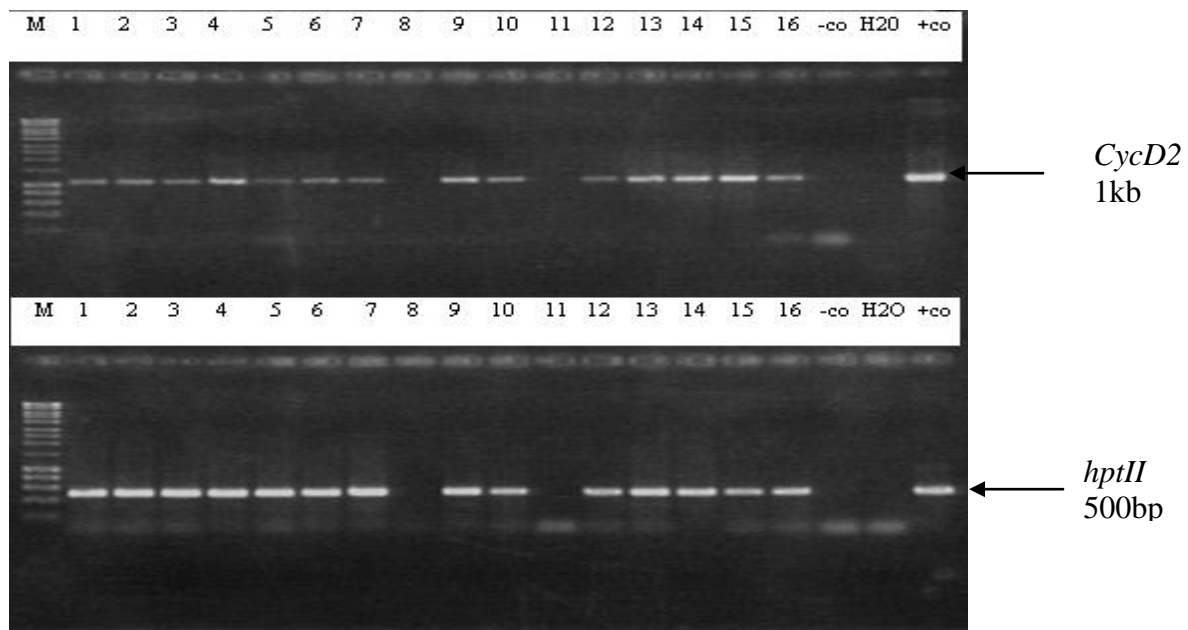

Figure 4.9 Agarose gel electrophoresis of PCR of DNA of representative transgenic plants from ‘Sukali ndiizi’ containing *CycD2* together with *hptII* genes. **M**, DNA sizing marker (Hyperladder1) of 200bp to 10,000bp from BIOLINE; **-Co**, negative control, non-transformed banana plant; **+Co**, positive control (Plasmid DNA); Upper panel and lower panel are PCR products for *Arath CycD2* and *hptII* genes in transgenic “Sukali ndiizi” respectively. Water was also included to check for any contamination in PCR reagents. Lanes 1-16 are independent lines of regenerants.

CHAPTER FIVE: DISCUSSION

Breeding for disease-resistant banana cultivars using classical methods remains a tedious endeavour because of high sterility, polyploidy, and long generation times of most of edible cultivars (Arinaitwe, 2008). Biotechnology involving modern tissue culture, cell biology and molecular biology provides an opportunity to develop new germplasm better adapted to changing demands (May *et al.*, 1995). *Agrobacterium* mediated transformation is a major DNA delivery system for novel transgenic technologies. However, low transformation efficiency has become the greatest challenge in the application of this technology in recalcitrant crops, especially monocotyledonous plants, like banana which are not naturally susceptible to *Agrobacterium spp.* (Philippe Vain, 2007).

A model for control of G1/S transition was proposed in which D-type cyclins are primary mediators of the G1/S transition and hence have a major responsibility for stimulating the mitotic cell cycle (Shen, 2001). Plant D-class cyclins play important roles in controlling the cell cycle in development and in response to external signal. *CycD2* is activated earlier in G1 and responds to sugar availability (Gaudin *et al.*, 2000; Riou-Khamlichi *et al.*, 2000). The *CycD2* overexpressed under the control of the 35S promoter enhanced growth in tobacco plants (Cockcroft *et al.*, 2000). These observations prompted us to test whether the *Arabidopsis CycD2* and *Musa CycD2* enhances transformation and regeneration efficiency in “Sukali ndiizi”, a monocotyledonous plant.

The PCR cloning used in this study was effective and efficient because it gave the expected bands sizes (Figure 4.1). Restriction and ligation enzymes were also effective tools in the preparation of *Musa CycD2* and *Arath CycD2*, especially in attaining the promoter and terminator as well as selectable marker genes. This was because of obtaining expected band sizes at every stage (Figure 4.1).

A number of genes have been isolated and used in genetic transformation of plants including banana (Rout *et al.*, 2000). Several of these genes have been cloned, and their expression regulated by CaMV 35S promoter. The CaMV 35S promoter, which is also used here, was preferred above other potential promoters because it is a more powerful promoter than others and is not greatly influenced by environmental conditions or tissue types (Sagi *et al.*, 1997).

Transgenic plant production has been intimately connected to the β -glucuronidase (*UidA* or GUS) gene used as a reporter or marker gene. The enzyme stability and the high sensitivity and amenability of the gus assay to qualitative (histochemical assay) and to quantitative (fluorometric or spectrophotometric assay) detection are some of the reasons that explain the extensive use of *uidA* gene in plant genetic transformation. Methods for *UidA* (GUS) gene detection have been thoroughly described in the literature (Cervera, 2005).

Histochemical gus assay results, used as a marker for transformation efficiency, showed that ECSs from cultivar “Sukali ndiizi” were competent and susceptible to

Agrobacterium tumefaciens infection and hence transformable. This was due to observation of blue colour in the stained cells and tissues. The GUS gene inserted in the transformed cells produced a protein which has enzymatic activity, β -galactosidase, which turned the colorless substrate (x-gluc in the stain) into blue. The results in this study annul the hypothesis that: “*Arath CycD2* and *Musa CycD2* cannot be successfully inserted into “Sukali ndiizi” cells”. Quantification of GUS expression results (Figure 4.2) indicated variable increased numbers of blue foci in different constructs (1550, 810, and 1710 per 0.5 PCV) compared to what has been previously reported (Khanna *et al.*, 2004). For example, in cultivar ‘Grand Nain’ and ‘Lady Finger’ 556 and 464 blue foci were observed. In Biotechnology laboratory at Kawanda, the figures are even much lower (National banana programme unpublished data).

Hygromycin B phosphotransferase (hptII) was used as a selectable marker and hence hygromycin (50 μ g/ml) was used as a selection agent for stable integration. Hygromycin is an aminoglycosidic antibiotic that kills plant cells by inhibiting protein synthesis (Bakker, 1992). The resistance gene codes for a *kinase (hptII)* that inactivates the toxic hygromycin through phosphorylation (Cabanas *et al.*, 1978).

Black cells (Figure 4.3) in the background are non-transformed and thus died due to the toxicity of the hygromycin antibiotic (Bakker, 1992). The white cells (Figure 4.3) show that *CycD2* genes together with *Hygromycin B phosphotransferase (hptII)* were inserted into the genome and therefore are resistant to hygromycin antibiotic (Cabanas *et al.*, 1978). The expressed *hptII* in the transformed “Sukali ndiizi” cells detoxifies hygromycin enabling the cells to withstand the selection pressure from the selective media (Cabanas

et al., 1978). This is also due to the fact that the *hptII* and *CycD2* were on the same T-DNA. Similarly, high co-occurrence of genes has been observed in banana (Arinaitwe, 2008). Li *et al.* (1991) and Liu *et al.* (1994) have also used *SAUR* gene/*gusA* reporter gene fusions to investigate auxin-stimulated events in transgenic tobacco plants.

This study also tested the hypothesis that *Arath CycD2* and *Musa CycD2* do not increase regeneration frequency in “Sukali ndiizi”. The transformed clones that survived selection as well as the regenerated plants (Table 3.1) per construct were quantified in comparison to the controls containing only the vector without *CycD2* gene. Regeneration efficiency of 47% - 62% as observed is far higher than that of the control (18%). The hypothesis was, therefore, rejected. The transformants were detected positive by *gus* assay of different tissues as well as PCR analysis. The few regenerated escapes could be attributed to either the protection of non-transformed cells by neighboring transgenic cells, or the persistence of *Agrobacterium* cells in plant tissues after co-cultivation. Comparison of the obtained regeneration efficiencies of *Musa CycD2* and *Arath CycD2* led to rejection of the hypothesis that states: “*Musa CycD2* has less effect on the regeneration efficiency than *Arath CycD2* in banana, cv. “Sukali ndiizi”. This was because of lack of significant difference in their performance ($P \leq 0.166$) regardless of their difference in origin. The high regeneration efficiency of 89% in non-transformed controls is expected because these cells were neither subjected to any stress of antibiotics nor *Agrobacterium* infection like the transgenic counter parts.

The absolute requirement of S-phase (DNA duplication) for *Agrobacterium* mediated transformation has been demonstrated (Villemont *et al.*, 1997). Although there was no significant difference in gus staining in cells transformed with *CycD2* genes compared to that of an empty vector, post infection viability was highly improved (Table 4.1). This is a significant observation and explains why despite high initial reporter gene expression in cells of many monocotyledonous plants like banana, cells do not regenerate because they are either arrested or endoreduplicated. *CycD2* genes could have increased transformation by promoting cell division and proliferation which are required for stable transformation (Villemont *et al.*, 1997).

Exploitation of highly dividing cells for integration of foreign genes has been reported and these include reports of increased gene transfer by wounding, pre-culture of explants on auxin rich media, and use of previously sub-cultured plant cells (Arinaitwe 2008). The observed increase in transformation efficiency has been attributed to be due to stimulation of cell division and activation of DNA replication machinery (Sangwan *et al.*, 1992). Chateau *et al.* (2000) observed similar effects in *Arabidopsis*. Recently, several *Agrobacterium* gene transfer system reviews have highlighted the importance of cell division during gene transfer (Tzfira *et al.*, 2002; Gelvin, 2003; Arias *et al.*, 2006). Arias *et al.*, (2006) particularly emphasized on the importance of cell division, emphasizing that cell cycle phases S-M were vital for plant cell transformation. The reasoning is based on the fact that plant cell DNA repair machinery is more active during cell division due to on-going DNA replication processes (Tzfira *et al.*, 2002). In the related study, ectopic expression of *Arath CycD2* in transgenic tobacco (*Nicotiana tabacum*) and *Arabidopsis*

thaliana plants led to accelerated development and a faster growth rate attributable to a reduction in cell cycle length caused by a reduced G1-phase duration (Cockcroft *et al.*, 2000).

Transgenic cells as well as plants could have also responded better to sucrose in media compared to controls. This could be because *CycD2* expression and activity respond to both extracellular signals such as sugars (Riou-Khamlichi *et al.*, 2000) and developmental signals. It is also well known that during G1 phase, cells must integrate relevant signals, like sugar, before making the decision to initiate DNA duplication which implies commitment not only to S phase but also to completion of cell division (Dewitte and Murray, 2003).

Observed lack of significant difference in the performance of *Arath CycD2* and *Musa CycD2* contributes to the growing evidence that genes which control the cell cycle are conserved (Arias, 2006).

Reduced regeneration as a result of death of cells after *Agrobacterium* mediated transformation has also been reported to be due to necrosis and induced hypersensitive response and was significantly reversed in banana cells when cells were transformed with anti-apoptosis genes (Khanna *et al.*, 2007). Although this approach is interesting, banana cells that expressed anti-apoptosis genes did not respond to biotic stress (Arinaitwe, 2008). It is, therefore, possible that the cells which still died after the insertion of *CycD2* genes might have undergone apoptosis.

CHAPTER SIX: CONCLUSIONS AND RECOMMENDATIONS

6.1 CONCLUSIONS

The results presented here show that “Sukali ndiizi” cells are highly competent and transformable by *Agrobacterium* mediated transformation system and, regardless of the origin, *CycD2* genes have the potential to significantly improve transformation and regeneration frequency of “Sukali ndiizi” cells”.

The transferred *CycD2* genes might also stimulate cell division in tissues leading to early maturity in the transgenic “Sukali ndiizi” plants.

Importantly, an efficiency of more than 50%, as demonstrated under this study with “Sukali ndiizi” ECSs, suggests that selectable markers could be unnecessary in the selection of transgenic plants.

This dissertation contributes to the current information about improvement of transformation and regeneration efficiency of bananas and also the role of *CycD2* genes in the improvement. Studies in the recommended areas will add useful information on the long term integration and stability as well as heritability of transgenes in these transgenic “Sukali ndiizi” plants.

6.2 RECOMMENDATIONS

The following recommendations can be made about the transformation of “Sukali ndiizi” cells with *CycD2* genes.

1. There is need to perform further molecular analyses like Southern blotting, RT-PCR and Western blotting on screen house samples of transgenic “Sukali ndiizi” to ascertain the gene integration pattern as well as gene stability in these plants.
2. Morphological characteristics, of the regenerated plants, like leaf emergence rates, pseudostem vigor and girth width also need to be evaluated to establish the expression status as well as effect of *CycD2* genes to the growth rate of the transgenic plants in vivo.
3. Flow cytometric analysis should also be performed to investigate entry of cells into the cell cycle and ratio of cells in different phases in suspension to ascertain the relationship between cell cycle phases and rate of transformation in banana cells.
4. Other cell cycle genes that are thought to affect the cell cycle like *CycD3* should be tested to compare their effects, on regeneration efficiency of “Sukali ndiizi”, with that of *CycD2*.

REFERENCES

Arias S. Filichkin A. and Strauss H. (2006). Divide and conquer: development and cell cycle genes in plant transformation. *Trends in biotechnology*. 24(6):267-273.

Arinaitwe G. (2008). An improved *Agrobacterium* mediated transformation method for banana and plantain (*Musa* spp). A PhD thesis submitted to the Catholic University of Leuven. 16-32.

Andreas U., Harm N., Xiangyu R., Ton B., Rene´ G. And Jack A.M. (2007). Primer3 Plus, an enhanced web interface to Primer3. *Nucleic Acids Research*, 35(10):1093.

Bakker EP. (1992). Aminoglycoside and aminocyclitol antibiotics: Hygromycin B is an atypical bactericidal compound that exerts effects on cells of *Escherichia coli* characteristics for bacteriostatic aminocyclitols. *Journal of Genetics and Microbiology*. 138: 563-9.

Cabanas MJ., Vazquez D., Modolell J. (1978). Dual interference of hygromycin B with ribosomal translocation and with aminoacyl-tRNA recognition. *European Journal of Biochemistry*. 87(1):21-27.

Carvalho CHS, Zehr UB, Gunaratna N, Anderson J, Kononowicz HH, Hodges TK, Axtell JD (2004). *Agrobacterium*-mediated transformation of sorghum: Factors that affect transformation efficiency. *Genet. Mol. Biol.* 27: 259-269.

Cervera, M (2005). Histochemical fluorimetric assays for *UidA* (GUS) gene detection. *Methods of Molecular Biology*, 286:203-14.

Chateau.S., Sanguan, R .S. and Sangwan Noreel, B.S. (2000). Competence of *Arabidopsis thaliana* genotypes and mutants for *Agrobacterium tumefaciens* mediated gene transfer: Role of phytohormones. *Journal of Experimental Botany* 51:1961-1968.

Cheng, M., Lowe, B.A., Spenser,T.M., Ye, X. and Armstrong,C.L. (2004). Factors influencing *Agrobacterium*-mediated transformation of monocotyledonous species. *In vitro Cellular and Developmental Biology-Plant* 40:31-45.

Cockroft C.E, Healy, J.M., and Murray, J.A. (2000). *Cyclin* control of growth rates in plants. *Nature* 405, 575-579.

Cote, F.X, Domergue, M., Marson, R., Schwendiman S., Tieson J., and Escalant J. V (1996). Embryogenic cell suspension from male flowers of *Musa* AAA cv. Grand naine. *Physiol Plant* 97:285-290.

De Clercq, J., Zambre, M.,Van Montagu, M., Dillen,W and Angenon.G (2002). An optimised *Agrobacterium*-mediated transformation procedure for *Phaseolus acutifolius* A. Gray. *Plant Cell Rep* 21:333-340.

De la Riva, G.A., Gonzalez-Cabrera, J., Vazquez-Padron, R., Ayra-pardo, C (1998). *Agrobacterium tumefaciens*: a natural tool for plant transformation. *Electronic Journal of Biotechnology* 1:118-134.

Dellaporta, S.L., Wood, J. & J.B. Hicks (1983). A plant DNA mini-preparation: version 2. *Plant Molecular Biology Reporter* 1, (14) 19-22.

Dewitte, W. and Murray, J.A.H. (2003). The plant cell cycle. *Annu.Rev.plant Biol.*54, 235-264.

Dewitte W., Simon S., Annet A., Spencer C., Mergit menges, Nils Braun, Carl C, and James M. (2007). *Arabidopsis CycD3* type link cell proliferation and endocycles and is rate limiting for cytokinin response. PNAS 104.14537-14542.

Elliott A. R., J. A. Campbell, B. Dugdale, R. I. S. Brettell and C. P. L. Grof (1999). Green-fluorescent protein facilitates rapid *in vivo* detection of genetically transformed plant cells. Plant Cell Report.18:707-714.

FAO (1999b). The impact of banana supply and demand changes on income, employment and food security. BA/TF 99/6. Rome.

Ganapathi, T.R., Higgs, N.S., Balint-Kurti, P.J., Arntzen, C.J., May, G.D and VanEck, J.M. (2001). *Agrobacterium*-mediated transformation of embryogenic cell suspensions of the banana cultivar ‘Rasthali’ (AAB). Plant Cell Reports, 20: 157-162.

Gaudin V., Lunness PA., Fobert PR., Towers M., Riou-Khamlichi C, (2000). The expression of *D-cyclin* genes defines distinct developmental zones in snapdragon apical meristems and is locally regulated by the Cycloidea gene. Plant Physiol. 122:1137–48.

Gelvin, S.B. 2003. Improving plant genetic engineering by manipulating the host. Trends Biotechnol. 21:95-98.

Gold, C.S., Ogenga-Latigo, M.W., Tushemereirwe, W.K., Kshaija, I.N and Nankinga, C. (1993). Farmers’ perception of banana pest constraints in Uganda. In: Gold, C.S and Gemmil, B. (Eds). Biological and integrated control of highland banana pests and diseases. Proceedings of a research co-ordination meeting, Cotonou, Benin, 12-14 November 1991. International Institute of tropical Agriculture, Ibadan, Nigeria, 3-24.

<http://webschoolsolutions.com/biotech/transgen.htm>. Major concepts in biology. BIO 105.

<http://www.mun.ca/biology/desmid/brian/BIOL2060/BIOL2060-19/1940.jpg>. Principles of Cell Biology (BIOL2060).

Inze D. and Lieven De Veylder (2006). Cell cycle regulation and plant development. Annual Review of Genetics, 40:77-105.

Jefferson, R. A. (1987). Assaying chimeric genes in plants: The GUS gene fusion system. Plant Mol. Biol. Rep., 5: 387-405.

Jones, H.D (2005). Wheat transformation: current technology and applications to grain development and composition. J Cereal Sci. 41:137–147.

Kalyebara, R., Wood, S and Abodi, P. (2005). The potential economic benefits of improved banana productivity in Uganda: an industry scale analysis. *IFRI BRIEF 9*.

Karugaba, A and Kimaru, G. (1999). Banana production in Uganda, An essential food and cash crop. RELMA; Technical hand book, 7-16.

Khanna H., Becker D., Kleidon J., and Dale J. (2004). Centrifugation assisted *Agrobacterium tumefaciens*-mediated Transformation of embryogenic cell suspensions of banana. Molecular breeding, 14:239-252.

Khanna H., Jean-Yves Paul., Robert M., Harding., Martin B., Dickman, and James D. (2007). Inhibition of *Agrobacterium*-induced cell death by antiapoptotic gene expression leads to very high transformation efficiency of banana. Molecular Plant Microbe Interactions, Vol. 20: 1048–1054.

Kiggundu, A. (2008). Engineering plant cysteine protease inhibitors for the transgenic control of banana weevil, *Cosmopolites sordidus* (Germar) (*Coleoptera: Curculionidae*) and other coleopteran insects in transgenic plants. PhD thesis, University of Pretoria South Africa, 66-97.

Lai, Y.C. and Chen, L.F.O. (2002). Low cytometric analysis of nuclear cell cycle phases in relation to plant regeneration in *Petunia hybrida*. *J. Genet. Mol. Bio.* 13, 173-180.

Li, Y., G. Hagen, and T.J. Guilfoyle (1991). An auxin-responsive promoter is differentially induced by auxin gradients during tropisms. *Plant Cell* 3:1167-1175.

Liu, Z.-B., T. Ulmasov, X. Shi, G. Hagen, and T.J. Guilfoyle (1994). Soybean GH3 promoter contains multiple auxin-inducible elements. *Plant Cell* 6:645-657.

May, G.D., Afza, R., Mason H.S., Mieccko A., Novak FL., and Arntzen, C.J (1995) Generation of transgenic bananas (*Musa acuminata*) plants via *Agrobacterium* mediated transformation. *Biotechnology*, 13:486-492.

McCullen. C.A and Binns, A.N. (2006). *Agrobacterium tumefaciens* and plant cell interactions and activities required for inter kingdom macromolecular transfer. *Annual Review of Cell Development and Biology*, 22:101-27.

Menges M., Anne K. Samland, Séverine P. and James A.H. M (2005). The D-Type Cyclin *CYCD3; 1* is Limiting for the G1-to-S-Phase Transition in Arabidopsis. *Plant Cell* 18: 893–906.

Meredith Ellen Crosby (2006). G2 Phase Cell Cycle Regulation by E2F4 following Genotoxic Stress. A PhD thesis submitted in partial fulfillment of the requirements for the Degree of Doctor of Philosophy Case Western Reserve University. 42-57.

Murashige T & Skoog F. (1962). A revised medium for rapid growth and bioassays with tobacco tissue cultures. *Physiol.Plant.* 15: 473-97.

Murray JAH, Freeman D, Greenwood J, Huntley R, Makkerh J, (1998). Plant D *Cyclins* and retinoblastoma (Rb) protein. *Plant Physiol.* 119: 343-352.

Pena L, Rosa M, Magdalena C, Jose A and Luis Navarro (2004). Early events in *Agrobacterium* mediated genetic transformation of citrus explants. *Annals of botany,* 94:67-74.

Philippe Vain, 2007. Thirty years of plant transformation technology development. *Plant biotechnology journal.* 5: 221-229.

Riou-Khamlichi C, Menges M, Healy JM, Murray JAH. (2000). Sugar control of the plant cell cycle: differential regulation of *Arabidopsis* D-type *cyclin* gene expression. *Molecular Cell Biology,* 20:4513–21.

Rout G.R., Samantaray S, and Das P. (2000). Biotechnology of Bananas: A review of recent progress. *Plant biotechnology,* 2: 512-524.

Sági, L., Remy, S., Swennen, R (1997). Genetic transformation for the improvement of bananas - A critical assessment Focus Paper II. Networking Banana and Plantain: INIBAP Annual Report 1997, INIBAP, Montpellier, France (1998) 33-35.

Sagi, L, Panis, B, Remy, S, Schoofs, H De Smet, K, and Swennen, R 1995. Genetic transformation of Banana and plantain via particle bombardment. *Biotechnology* 13, 481-485.

Sangwan RS., Bourgeois Y., Brown S., Vasseur G. and Sangwan-Norreel B. (1992). Characterization of competent cells and early events of *Agrobacterium*-mediated genetic transformation in *Arabidopsis thaliana*. *Planta* 188: 439–456.

Se-Jun Oh, Su-Jung K., Youn Shic K., Su-Hyun P., Sun-Hwa H., and Ju-Kon K. (2008). *Arabidopsis* cyclin D2 expressed in rice forms a functional

cyclin-dependent kinase complex that enhances seedling growth. *Plant Biotechnology* 2:227–231.

Shen H.W. (2001). The plant cell cycle: G1/S regulation. *Euphytica* 118,223-232.

Smits, V. A and Medema, R. H. (2001). Checking out the G (2)/M transition. *Biochem Biophys Acta* 1519, 1-12.

Talwana, H.A.L., Speijer, E.R., Gold, C.S., Swennen, R.L and De Waele, D. (2003). A comparison of the effects of the nematodes *Radopholus similis* and *Pratylenchus goodeyi* on growth, root health and yield of an East African Highland banana (*Musa* AAA-group). *International Journal of Pest Management*, 49(3):199-204.

Tripathi L., Jaindra N. and Tushemereirwe W. (2008). Rapid and efficient production of transgenic East African Highland Banana (*Musa spp.*) using intercalary meristematic tissues. *African Journal of Biotechnology*, 7: 1438–1445.

Tushemereirwe, W., Kangire, A., Ssekiwoko, F., Offord, L.C., Crozier, J., Boa, E., Rutherford, M and Smith, J. (2004). First report of *Xanthomonas campestris* pv. *musacearum* on banana in Uganda. *Plant Pathology*, 53:802.

Tzfira, T., Vaidya, M and Citovisky, V (2002). Increasing plant susceptibility to *Agrobacterium* infection by over expression of *Arabidopsis* VIPI gene. *Proc Acad Sci.* 99:10435-10440.

Villemont E., Dubois F., Sangwan R.S., Vasseur G., Bourgeois Y., Sangwan-Norreel BS (1997). Role of the host cell cycle in *Agrobacterium*-mediated genetic transformation of petunia: Evidence of an S-phase control mechanism for T-DNA transfer. *Oxford journals.* 1:1333-1961.

Zambryski, P.C (1998). Basic processes underlying *Agrobacterium*-mediated DNA transfer to plant cells. *Annual Review of Genetics*, 22:1-30.

Zuo J., W Niu, Y Ikeda and N.H Chua (2002). Marker-free transformation: increasing transformation frequency by the use of regeneration-promoting genes. *Current Opinion in Biotechnology*, 13, 173–180.

APPENDICES

Appendix 1: GUS staining solution (final concentrations):

0.2% Triton X-100

50mM NaHPO₄ Buffer (pH7.0)

2mM Potassium Ferrocyanide

2mM Potassium Ferricyanide

8 mM EDTA

10% Triton X-100

0.5M NaHPO₄ Buffer (pH7.2)

100 mM Potassium Ferrocyanide (Store in the dark at 4°C)

100mM Potassium Ferricyanide (Store in the dark at 4°C)

100mM X-Gluc (5-bromo-4-chloro-3-indolyl β -D-glucuronide cyclohexamine salt) in DMSO

N/B. Filter-sterilize using 0.2 micro filter

Appendix 2. DNA Extraction Buffer (Final concentrations):

100mM Tris (pH 8.0) 4% (w/v) polyvinylpyrrolidone (PVP)

10mM β -mercaptoethanol (BME)

100mM Tris-HCl (pH 8.0)

50mM EDTA

100mM NaCl

Other Required Reagents for DNA extraction:

20% (w/v) sodium dodecyl sulphate (SDS)

5M potassium acetate (Stored at -20°C)

70% ethanol (stored at -20°C)

Absolute isopropanol (stored at -20°C)

Appendix 3. TE Buffer:

10mM Tris (pH 8.0)

1mM EDTA

Appendix 4. TAE electrophoresis buffer (50x stock)

Trisma base (242g)

Glacial acetic acid (57.1 ml)

0.5 M EDTA (P^H 8.0) (100ml)